

B 0 2 - T 1 7 0

Operation Manual

Panoramic Radiograph

Bel-Cypher

Notice to the operator and maintenance supervisor

***Read this instruction manual before operation. After reading this manual, safely keep this near the X-ray machine for the easy access.**

The classification is shown as follows

According to the type of protection against electric shock. : Class I

According to the degree of protection against electric shock. : Type B applied part

TAKARA BELMONT CORPORATION.

B 0 2 - T 1 7 0

**Thank you very much for purchasing our equipment Model Bel-Cypher.
Please read this operation manual carefully before operation in order to use the X-Ray
machine properly and safely.**

CONTENTS

| | |
|--|---------------|
| 0 1. INTRODUCTION | 0 1 – 1 / 2 |
| 0 2. WARNING | 0 2 – 1 / 6 |
| 0 3. Explanation of Equipment | 0 3 – 1 / 1 |
| 0 4. Specifications | 0 4 – 1 / 2 |
| 0 5. Standard Accessories | 0 5 – 1 / 1 |
| 0 6. Name of each parts | 0 6 – 1 / 1 |
| 0 7. Explanation of each parts | 0 7 – 1 / 3 |
| 0 8. Explanation of Operation Panel | 0 8 – 1 / 1 |
| 0 9. Preparations before exposure | 0 9 – 1 / 1 |
| 1 0. Flow Chart of Exposure | 1 0 – 1 / 1 |
| 1 1. Operation Procedure for Panorama | 1 1 – 1 / 1 4 |
| 1 2. Operation Procedure for TMJ Lateral | 1 2 – 1 / 9 |
| 1 3. Table of Exposure Settings | 1 3 – 1 / 1 |
| 1 4. Magnification of Image | 1 4 – 1 / 1 |
| 1 5. Daily Maintenance | 1 5 – 1 / 1 |
| 1 6. Trouble Shooting | 1 6 – 1 / 1 |
| 1 7. X-ray Tube Focus and Sensor Layout | 1 7 – 1 / 2 |
| 1 8. Physical Dimensions | 1 8 – 1 / 2 |
| 1 9. Labels | 1 9 – 1 / 2 |
| 2 0. Technical Data | 2 0 – 1 / 2 |
| 2 1. Maintenance | 2 1 – 1 / 2 |

2 2 . Contact Information







2 2 – 1 / 1

2 3 . Revision Record of this manual

2 3 – 1 / 1

01. INTRODUCTION

1. Read this manual carefully when you use this equipment for the first time.
2. Be sure to observe warning sentences and forbidden matters at the operating time of the equipment.
3. Read the operation manual from the beginning to the end.
Reading the operation manual from halfway might lead to misunderstanding.
4. Read this manual again to confirm the portion in question if you have any questions.
5. Operation procedure of Panoramic radiograph is basis of X-ray radiograph.
Your can use this procedure for other radiograph (TMJ)
6. Explanation of operation procedure of other radiograph are omitted, if the procedures are same as the one of Panoramic radiograph.
Refer to operation procedure of panoramic radiograph, if you have any questions about operating procedures.
7. Discharge
Be sure to observe the contents of this operation manual.
Even if any trouble or an accident happens due to wrong use, we are not responsible for them.
8. Warrantee Period
Warrantee period is two years after purchase of the equipment.
We will repair failure or defect by this warranty. This warranty is void when failure or defect is caused by conditions beyond the manufacturer's control, such as damage resulting from mishandling, neglect, misuse, improper maintenance, accident or alteration or repair by anyone other than Belmont or authorized Belmont dealer. See warrantee card for more information.
9. Maintenance
Be sure to make proper maintenance of your equipment.
Maintenance responsibility of medical equipment lies on the user.
10. Period for repair and supplying parts
We will supply parts of the equipment for 10 years, after the manufacturing of this equipment is discontinued.
11.  mark means "Attention, consult accompanying documents".

12.  mark means “ Protective earth(ground) “.
13.  mark means “ OFF (Power: disconnection from the mains) “.
14.  mark means “ ON (Power: connection to the mains) “.
15.  mark means “Type B“ Applied part
16.  mark means “Class 2 Laser product.
17.  mark means ionising radiation.
18. No user serviceable items inside.
- 19 . Conformability of indicated X-RAY requirement was determined in accordance with R10 sequences that follows ISO497.
- 20 . The use of ACCESSORY equipment not complying with the equipment safety requirement of this equipment may lead to a reduced level of safety of the resulting system. Consideration relating to the choice shall include:
- Use of the accessory in the PATIENT VICINITY
- Evidence that the safety certification of the ACCESSORY has been performed in accordance to the appropriate IEC 60601-1 and / or IEC 60601-1-1 harmonized national standard.
- Computer and monitor shall comply with IEC60950-1 or IEC60601-1
- 21 . Original manual was created in Japanese.
- 22 . In addition to this operation manual, we supply Installation manual (I02-1167E)

02. WARNING



WARNING:

Always conform to the safety work standards.

Repair work for internal parts of the equipment involves high risk. This should be strictly conducted by an authorized service personnel only.

NOTES:

Details of WARNING are stated as follows in this manual:



DANGER:

Explains danger that may cause serious adverse effect to a human body.



WARNING:

Explains an instruction where a personal injury or a physical damage may occur.



CAUTION:

Explains an instruction that should be observed for safety reasons.



NOTE:

States descriptions which serve to improve work efficiency and to help user to understand instructions in the manual.

 **WARNING**

Precautions on use (and safety and hazard prevention) of medical electric/electronic equipment

1. DO NOT allow the person without expertise to use the equipment.

2. Pay attention to the following when installing the equipment.

- (1) Install the equipment to avoid splashing water.
- (2) Do not install the equipment to the place harmful to it due to atmospheric pressure, temperature, humidity, airflow, direct sunlight, dust, salinity and air including sulfur.
- (3) Pay attention to the safety conditions such as inclination, vibration and impact (including those in transportation).
- (4) Do not install the equipment to the place where chemicals are stored or gas generates.
- (5) Pay attention to commercial frequency of power, its voltage and allowable current (or power consumption).
- (6) Connect the equipment to the ground properly.

3. Check the following before using the equipment.

- (1) Check contact of switches, polarity, dial settings and indicators. Check that the equipment operates normally.
- (2) Check that the equipment is connected to the ground perfectly.
- (3) Check that all cords are connected properly and perfectly.
- (4) Pay attention to parallel use with other equipment as it may cause erroneous diagnosis or danger.
- (5) Recheck the external circuit connected directly to a patient.
- (6) Check the battery power.

4. Pay attention to the following when using the equipment.

- (1) Avoid exceeding the time and the radiation dose rate necessary for diagnosis.
- (2) Always monitor no abnormality in all equipments in use and the condition of a patient.
- (3) When any abnormality is observed in the equipment or the patient, take appropriate action such as to stop the equipment in the condition safe for the patient.
- (4) Do not allow a patient to touch the equipment.

5. Pay attention to the following after using the equipment.

- (1) After returning operation switches and dials to their original position before use in accordance with predetermined procedure, turn off the power.
- (2) Do not pull cords when removing them from the equipment.
- (3) Be careful for the following items for storage.
 - I) Store the equipment where water is not splashed on it.
 - II) Do not store the equipment to the place harmful to it due to atmospheric pressure, temperature, humidity, airflow, direct sunlight, dust, salinity and air including sulfur.
 - III) Pay attention to the safety condition such as inclination, vibration and impact (including those in transportation).
 - IV) Do not store the equipment to the place where chemicals are stored or gas generates.
- (4) After cleaning accessories, cords, and terminals, put them in order.
- (5) Keep the equipment clean for the next use.

6. When the equipment fails, DO NOT attempt to repair it by yourself.

Indicate that the equipment is in failure and consign its repair to special engineer.

7. DO NOT modify the equipment.

8. Maintenance and inspection

- (1) Be sure to perform regular inspection of equipment and its accessories.
- (2) When resuming to use the equipment that was not used for a long time, be sure to check that the equipment operates normally and safely before use.

DANGER

This equipment is an electric instrument. Avoid splashing water on it. Otherwise it causes electric shock and damage of the equipment.

DANGER

**This equipment is an electric instrument with high voltage circuit. Removing the equipment cover causes electric shock.
DO NOT open the cover by persons other than the vendor consigned for maintenance.**



WARNING

The management responsibility of use and maintenance of this equipment belongs to the user
The operation of this equipment is limited only to legally qualified persons.
User should not open the cover of the equipment. Contact your dealer for service.

**WARNING**

This equipment should be installed in the X-ray room surrounded by walls that have over 1.0 mmPb lead equivalence.

**WARNING**

When earthquake is warned, do not use the equipment.

After earthquake occurred, check the equipment and make sure the equipment works properly.

**WARNING**

This X-ray Unit may be dangerous to patient and operator, if safe exposure factors and operating instructions are not observed.

**WARNING**

Do not put things in area where the equipment moves.

**WARNING**

Put a X-ray protective apron on the patient.

**WARNING**

Disinfect the area where a patient and an operator might touch after each exposure.

**WARNING**

Operator should pay attention to a patient when the Sliding Unit moves up and down.

**WARNING**

When the equipment is not used, turn off "Power SW "

**WARNING**

When the equipment has trouble, turn off "Power SW " .

 **WARNING**

During an X-Ray exposure, only a patient and a helper (who is permitted to enter by an operator) are allowed to stay in X-Ray room.

The helper (hereinafter helper) in this manual, is defined as person who a doctor permits to assist a patient while taking a X-ray radiograph.

 **WARNING**

Watch a patient and the equipment during an exposure.

When you encounter any trouble, immediately release the exposure switch.

 **WARNING**

LASER, DOT NOT STARE INTO BEAM, CLASS 2 LASER PRODUCT

1. Laser Beam is applied. For safety, instruct a patient not to look at the laser beam.
2. Before the beam is lightened, lower the Frankfort Line Beam to the bottom.
3. Do not set the beam to patient's eyes.

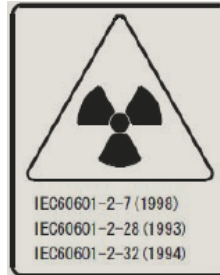
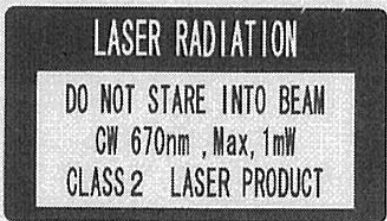

WARNING

THIS X-RAY UNIT MAY BE DANGEROUS TO PATIENT AND OPERATOR UNLESS SAFE EXPOSURE FACTORS AND OPERATING INSTRUCTIONS ARE OBSERVED.

 **CAUTION**

When the equipment and/or its' parts will be disposed, contact the dealer or our office.

 **CAUTION**

Disposal Process:
Dispose used bite fork covers and films according to the disposal procedures indicated by each manufacturer and the local code.

 **CAUTION**

Do not turn the Rotation Arm by hands. It might cause trouble of the equipment.

**CAUTION**

Operator shall instruct a patient not to move while X-ray exposes.

Operator shall instruct a patient not to move until the movement of ARM is finished during RESET movement.

**CAUTION**

The equipment shall be connected to the receptacle marked "Hospital Only" or "Hospital Grade".

03. Explanation of Equipment

1. Outline

Bel-Cypher can take radiographs of Panorama and TMJ.

2. Features

2. 1 . High Frequency X-ray Generator

The X-ray generator with the High Frequency Inverter delivers high quality radiation. This enables improved image quality while reducing radiation dose.

2. 2. X-ray Tube with minute focus

Owing to the minute X-ray Tube focus of 0.5mm, sharp and clear image is achieved.

2. 3. Versatile Combination of Exposure Factors

Tube voltage can be set from 60 kV to 80 kV by 1 kV step.

Tube current can be set at 2, 4, 6, and 8mA.

With wide range of exposure setting, Bel-Cypher can get ideal radiograph for every type of patient.

2. 4. Patient Positioning with 3 Beam Lines

Bright and Visible three laser beams make positioning very easy and accurate.

3. Configuration

Equipment consists of below assemblies.

1. Mechanical Assemblies, 2. X-ray Generator, 3. X-ray Controller

04. Specifications

| | |
|------------------------------|--|
| General name | Digital Panoramic Radiograph |
| Model | Bel-Cypher |
| Power Voltage | 120Vac 60Hz 1φ |
| Power Capacity | 11A |
| High Tension Generator | High Tension Generator (100kHz) |
| X-ray Tube Voltage | 60kV to 80kV (1kV step) |
| X-ray Tube Current | 2 to 8mA (2mA step) |
| Exposure method | Manual |
| X-ray Tube | D-052SB (Toshiba) |
| X-ray Tube Focal Spot | 0.5 mm |
| Total Filtration | 2.8mmAl (minimum) |
| Radiographic Mode | Panorama: (Adult, Child), Panoramic Bitewing (Adult, Child) TMJ: |
| Exposure Time | Panorama: 10 sec. Panoramic Bitewing:4.6 sec. TMJ: 2.5 sec. (x 4) |
| Magnification Ratio | Panorama: 1.2 to 1.3, Panoramic Bitewing: 1.2 to 1.3 TMJ: 1.2 |
| Image receiver | CCD Sensor |
| Beam for patient positioning | 3 beams |
| Dimension | W:920mm x D:1,100mm x H:2,200mm |
| Weight | Approximately 287 lb(130 kg) |

Environmental condition for Operation

Temperature : 41~95F (5~35°C)

Humidity : 30~85%

Pressure : 700~1060 hpa

Environmental condition for Storage

Temperature : 14~140F (-10~60°C)

Humidity : 10~95%

Pressure : 700~1060 hpa

Environmental condition for Transportation

Temperature : 14~140F (-10~60°C)

Humidity : 10~95%

Pressure : 700~1060 hpa

05. Standard Accessories

1. Head Holding Rods (Panorama)

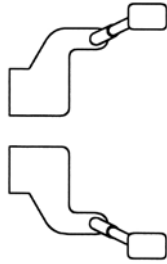

4. Bite Fork (Panorama)



2. Ear Rods (TMJ 4 sections)

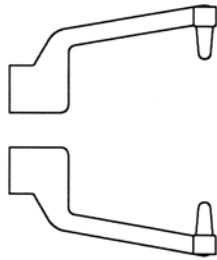

5. Exposure Switch (with holder)

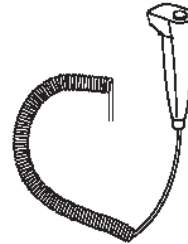

3. Chinrest (Panorama)

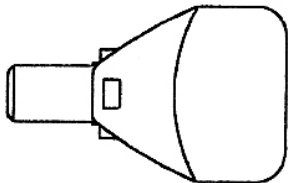

6. Bite Fork Cover(Disposable)

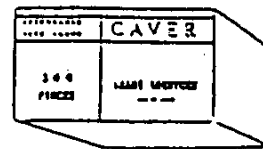

7. CD containing TWAIN Driver

06. Name of each parts

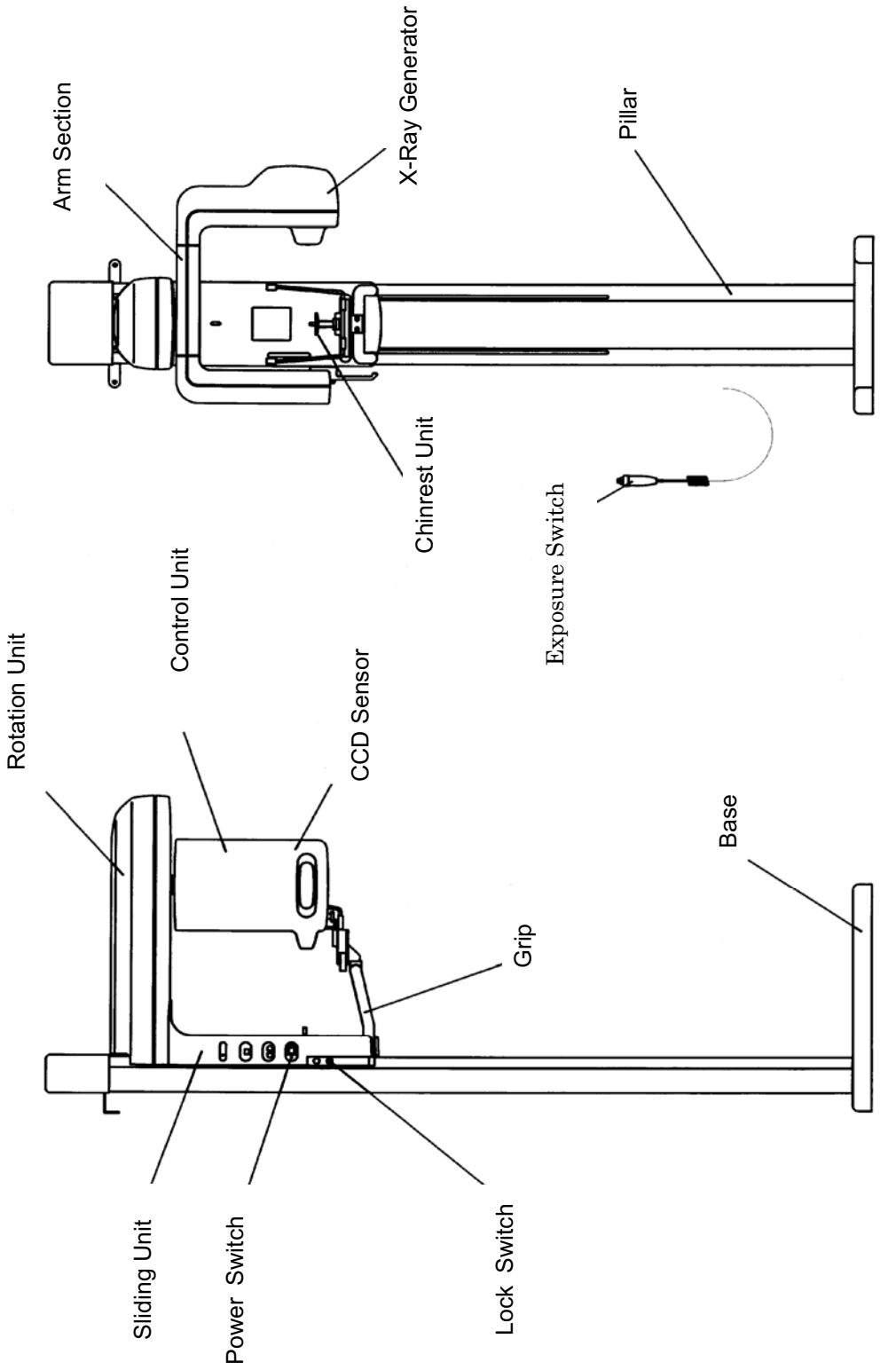

07. Explanation of each part

1. Power Switch

Caution

To protect this equipment, after turning the power on, wait 5 seconds before turning the power off. After turning the power off, wait 5 seconds before turning the power on.

Push "I" on the power switch to turn the power ON.

Push "O" on the power switch to turn the power OFF.

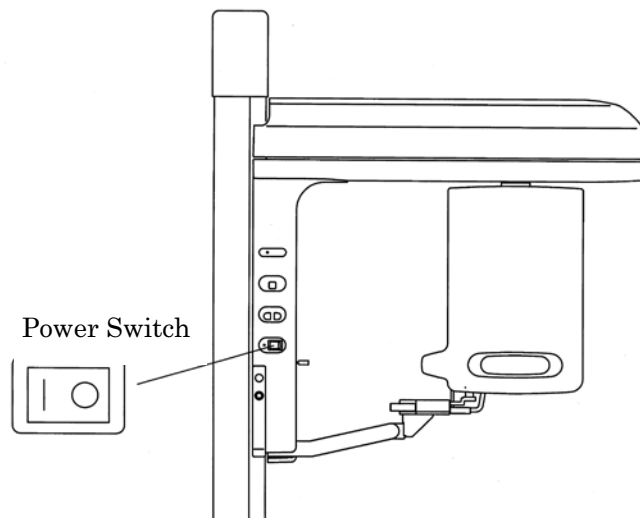

2. Reset Switch

Rotation ARM is set to the start position.

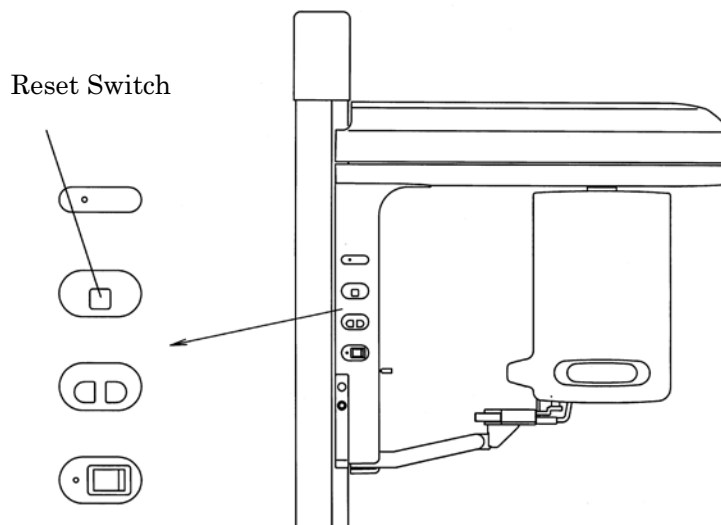

3. Electro -Magnetic Lock Switch (Overhead Carriage Release Switch)

While the main power is ON, the entire Overhead Carriage is magnetically locked at the position. By depressing this switch, Overhead Carriage can be free and move up/down. Overhead Carriage can be locked at the place where the switch is released.

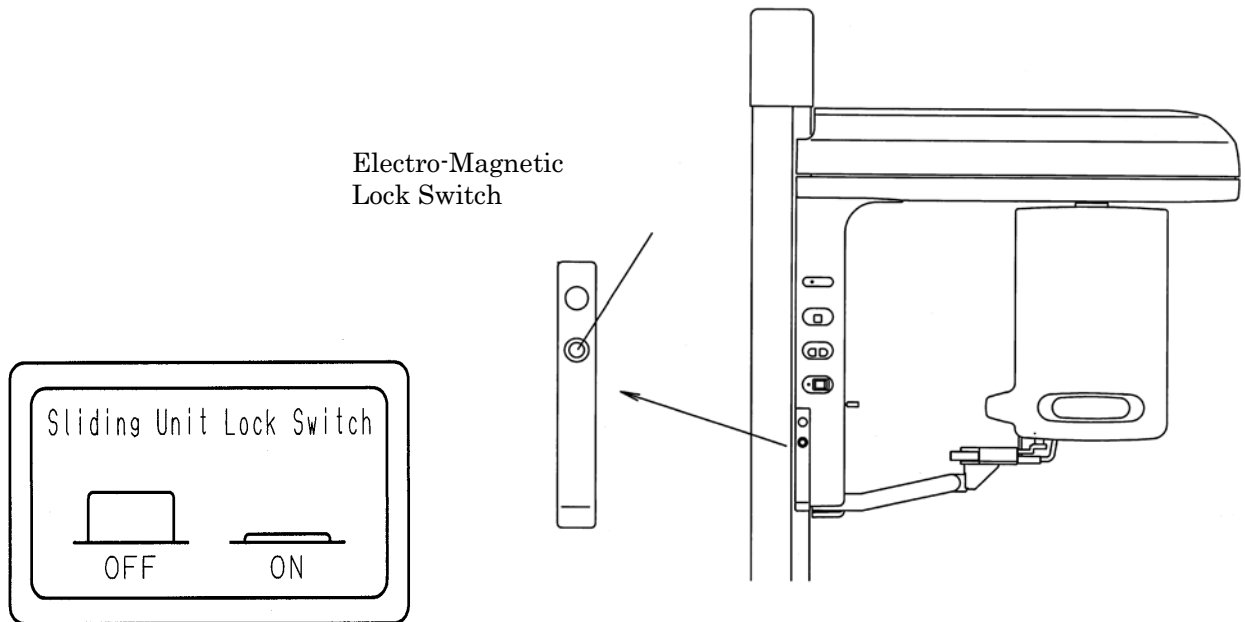

4. Holding Rods Adjuster Knob

Head Holding Rods(for Panoramic) and Ear Holding Rods(for TMJ) are used to hold the sides of the patient's head. Adjuster knob is used to open or close Head Holding Rods or Ear Holding Rods.

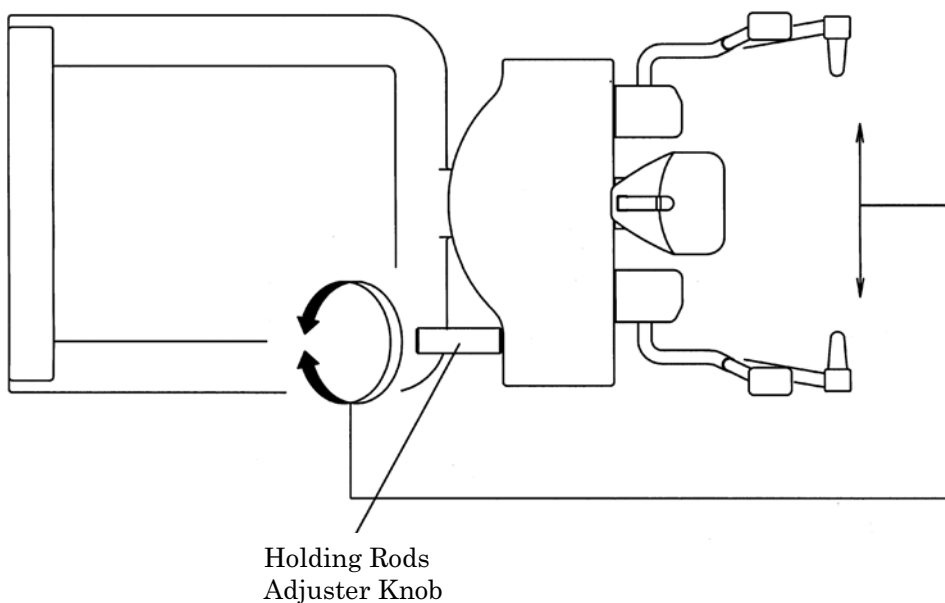

5. Names of Patient Positioning Laser Beams

Three Laser Beams are used for Patient Positioning

Median Plane Beam: Adjust to the center of the patient's face,

Frankfort Plane Beam: Adjust to the Frankfort Plane of a patient

Focus Beam: Adjust to the roots of upper and lower anterior teeth

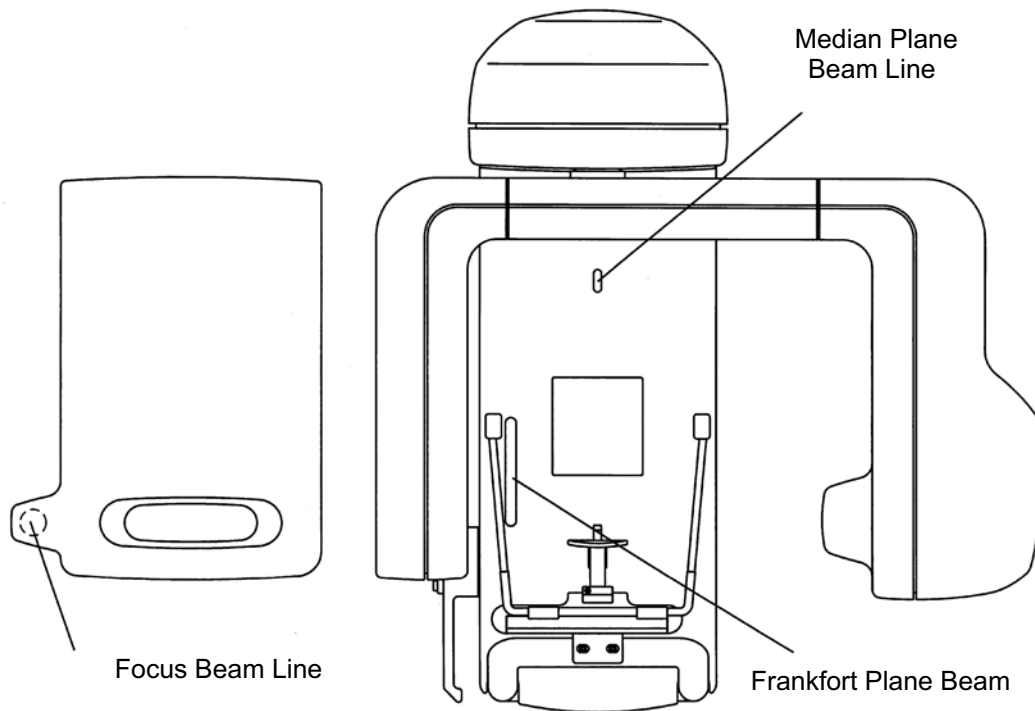

Caution

1. Laser Beams are used to position patient.
2. Warn patient not to look directly at the laser beam line.
3. Do not set the beam line to patient's eyes.

08. Operation Panel

1. Explanation of Operation Panel

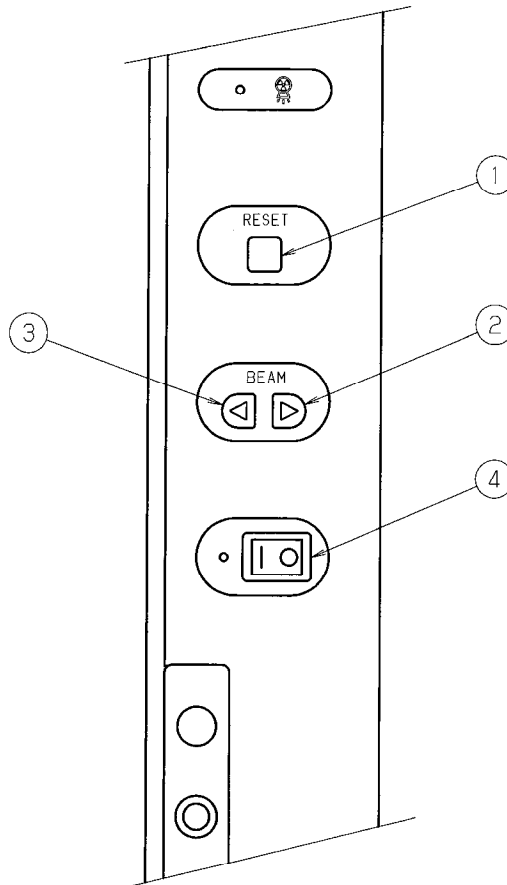

| No | Name | Function |
|----|--------------------------|--|
| 1 | Reset Switch | Set Rotation ARM to start position Reset Error Reset Read On |
| 2 | Focus Beam Line Backward | Move Focus Beam Line Backward |
| 3 | Focus Beam Line Forward | Move Focus Beam Line Forward |
| 4 | Power Switch | Turn the power on/off |

09. Preparation before exposure

1. Prepare accessories according to exposure mode

1. 1. Panorama

- 1) A pair of Head Holding Rod (Panorama)
- 2) A Chinrest (Panorama)
- 3) A Bite Fork
- 4) A Cover for Bite Fork (a article of consumption)

1. 2. TMJ Lateral 4 sections

- A pair of Ear Rod (TMJ Lateral 4 sections)

2. Put X-ray protector apron on patient

10. Flow Chart of Exposure

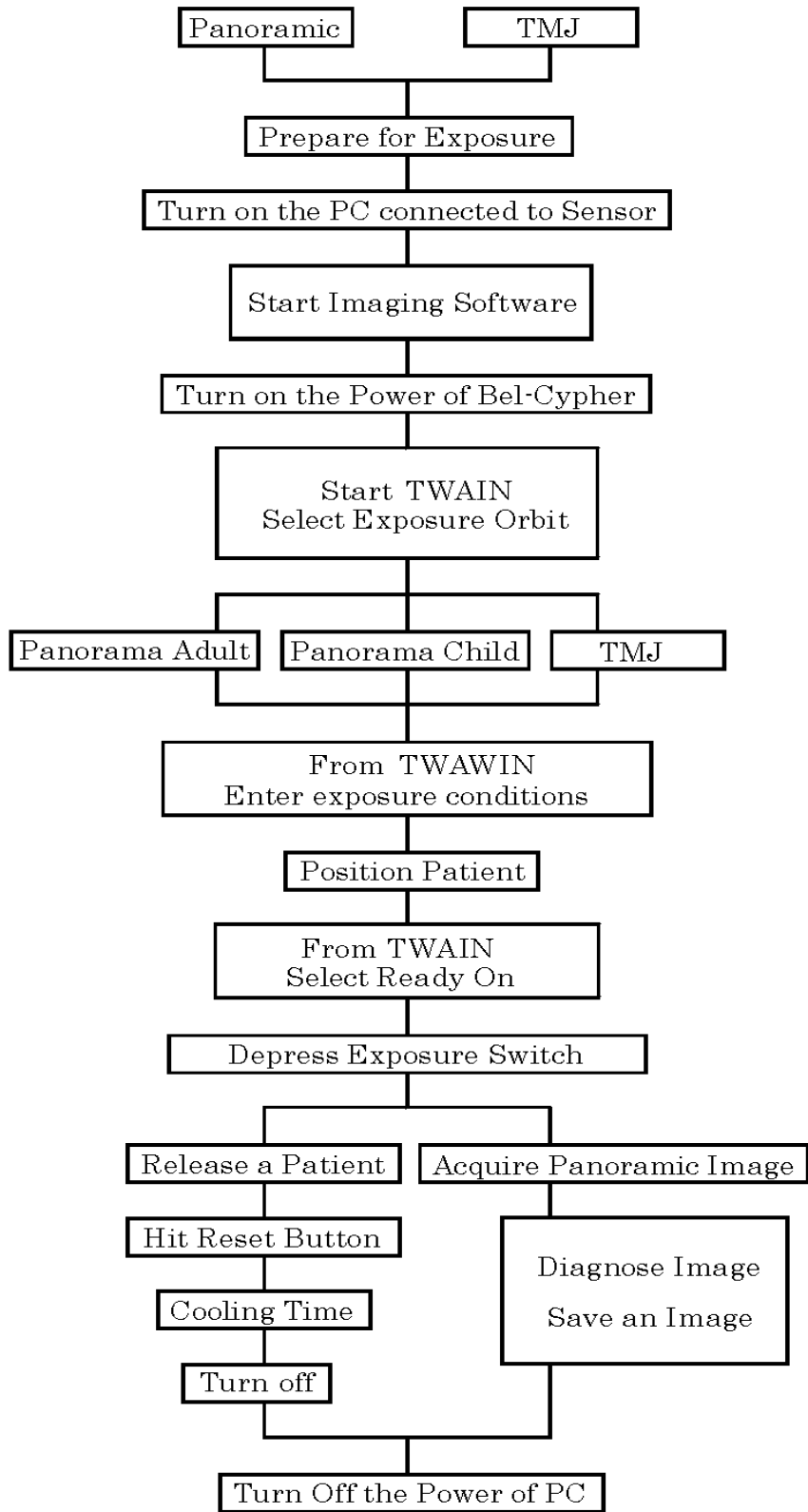

11. Operation Procedure for Panorama & Panoramic Bitewing

1. Learn Panoramic radiographic operation procedure that is basic X-ray radiograph.
2. Explanation of operation procedure in other modes that the same operation as Panorama is omitted. Refer to operation procedure for Panorama accordingly.

1. Preparation for exposure 1. Preparation for exposure

1. 1.
 - * X ray protective clothing
 - * Head holding Rods for Panorama
 - * Chinrest for Panorama
 - * Bite fork
 - * Bite fork cover
1. 2. Attach Chinrest and Head holding rods.

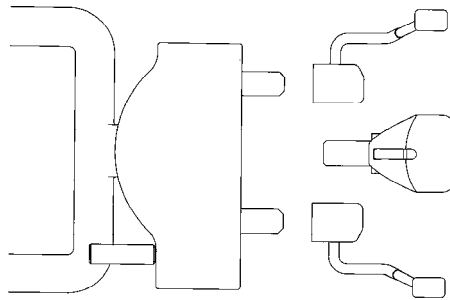

2. Turn the Power of Bel-Cypher

2. 1. Push "I" on the power switch to turn the power ON.

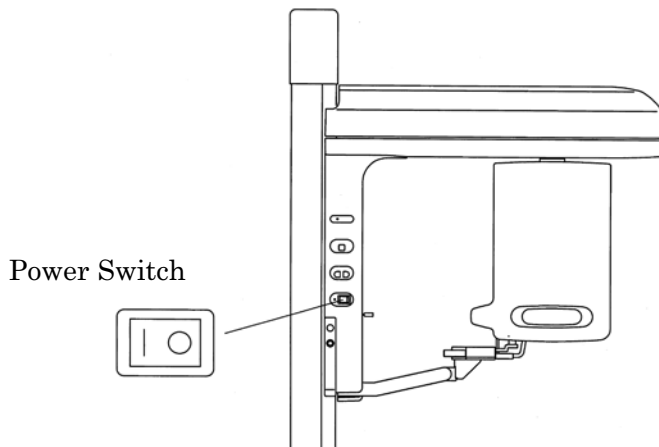

2. 2. If Rotation arm is not at starting position, hit Reset key.

Warning

By hitting Reset Key, Arm starts to rotate. Stay away from Rotation area to avoid injury.

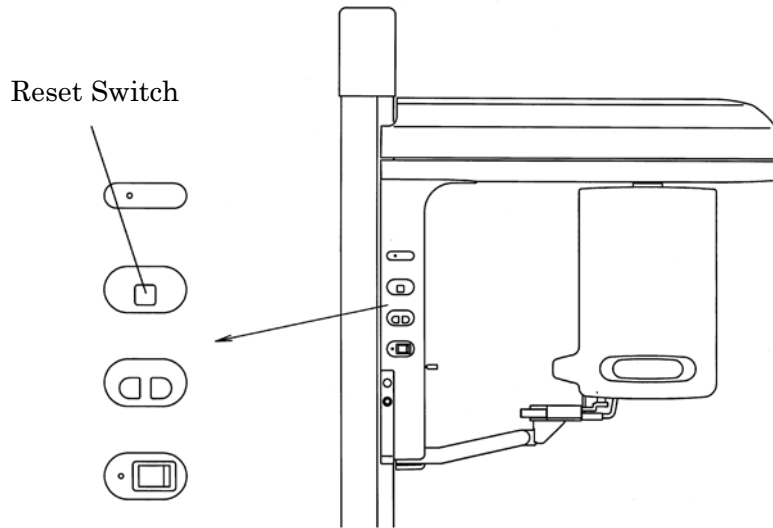

3. Exposure settings



Click either "Import" or "Scan" from diagnostic software / imaging software.

Check Power



If the power of the equipment is ON, click OK.

Reset



If you error message 「Equipment is not at the original position」 comes up,

Click RESET button.

Choose "Normal" or "Bitewing"



If you want regular Panoramic X-Ray, choose "Normal".

If you want Panoramic Bitewing, choose "Bitewing".

Choose Exposure Mode

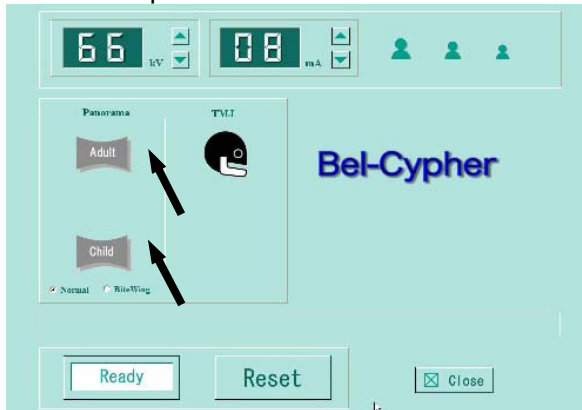

Choose either Adult or Child.
Selected mode will be highlighted.

kV and mA settings

Refer Sec 13 Table of Exposure Settings to choose appropriate setting values



Set kV
Click either ▲(up) or ▼(down) to set appropriate value.

Set mA
Click either ▲(up) or ▼(down) to set appropriate value.

Or simply click patient size icon.
You may need to adjust mA / kV on some patients.

4. Patient Positioning

Patient positioning is the key for successful radiograph. Carefully align patient.

4.1 By Turning adjuster Knob, open Head Holding Rods.

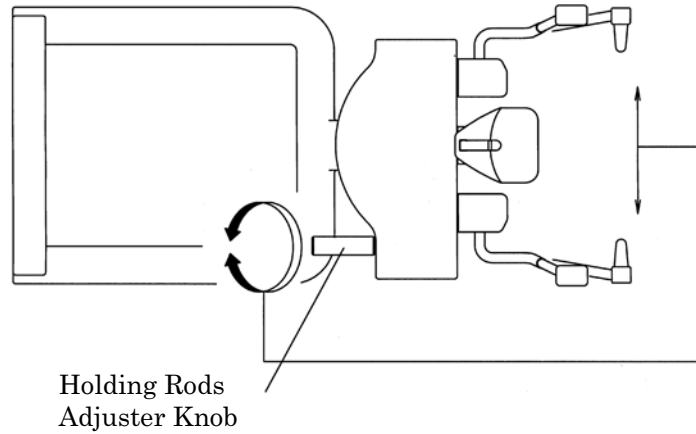

4. 2. Put Bite Fork Cover on a Bite Fork then insert to Chinrest Unit.

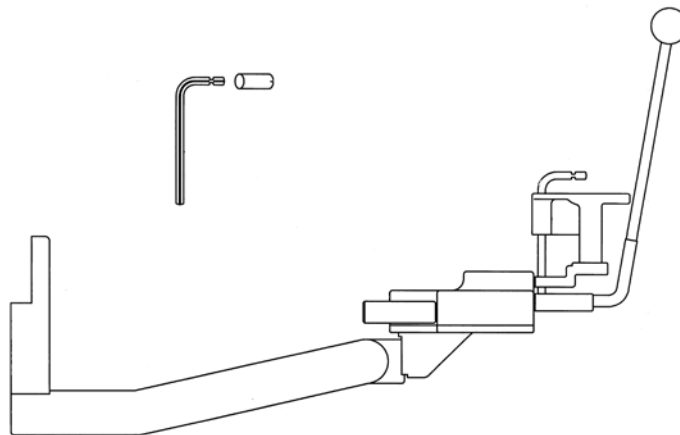

Caution

Change bite fork cover for each patient.

Dispose used bite fork covers according to the disposal procedures indicated by each manufacturer and the local code.

4. 3. Put X-ray protector apron on patient and the assistant

Caution

Please make sure to put X-ray protector apron on patient and the assistant

4. 4. Bring a patient close to Bel-Cypher.

4. 5. Adjust the height of Chinrest by moving Overhead Carriage up/down, so that the patient can stand upright and rest the chin on Chinrest.



Caution

By depressing Electro –Magnetic Lock Switch, magnetic lock is released.

While moving Overhead Carriage, be careful not to hit patient by Overhead Carriage.

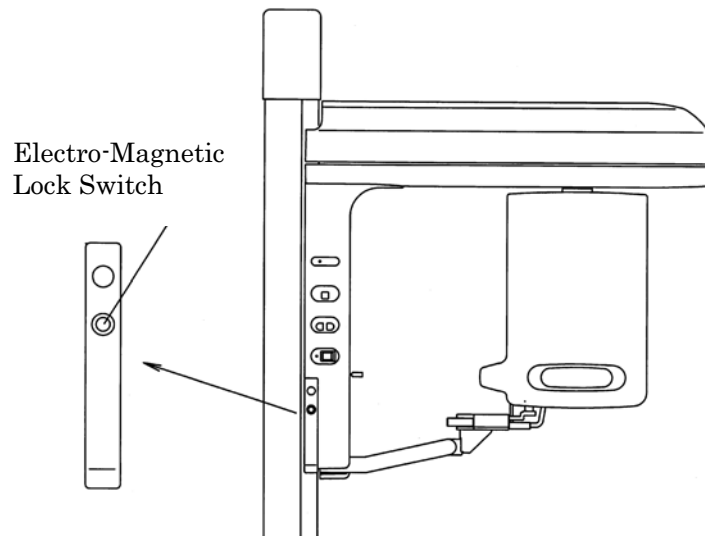

4. 6. Bring patient to stand on below foot position.

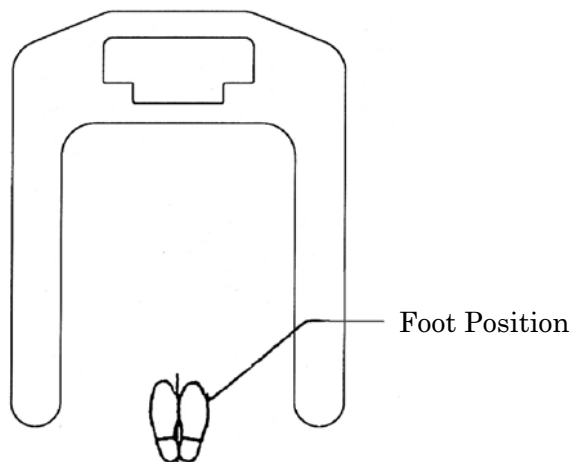

4. 7. Ask patient to hold grips.
4. 8. Bring Chinrest (Panorama) till Chinrest lightly touches the patient's mandible.
4. 9. Instruct patient to bite groove of Bite Fork with upper and lower anterior teeth.
Instruct patient to put chin on a Chinrest.

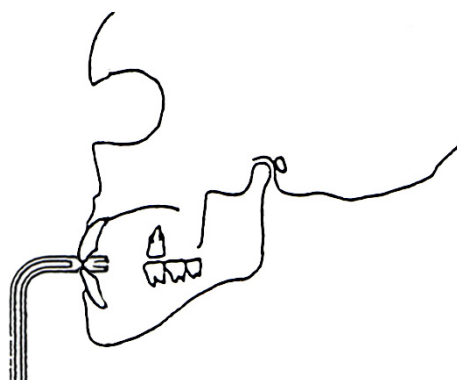

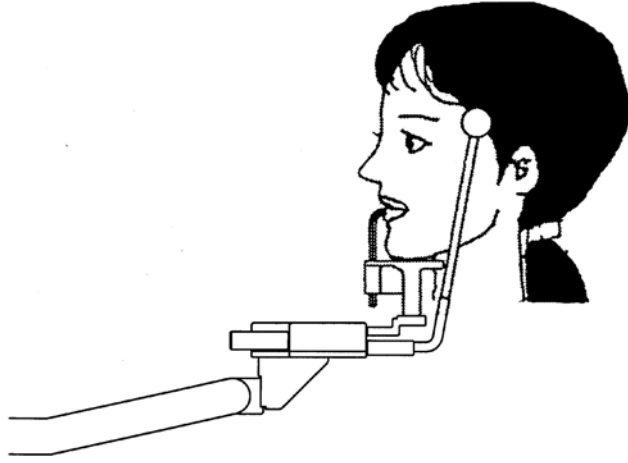

For an edentulous patient

Roll clean gauze on Bite Fork, and instruct patient to bite it.

4. 10. Lightly close the Head Holding Rods to position patient's head.

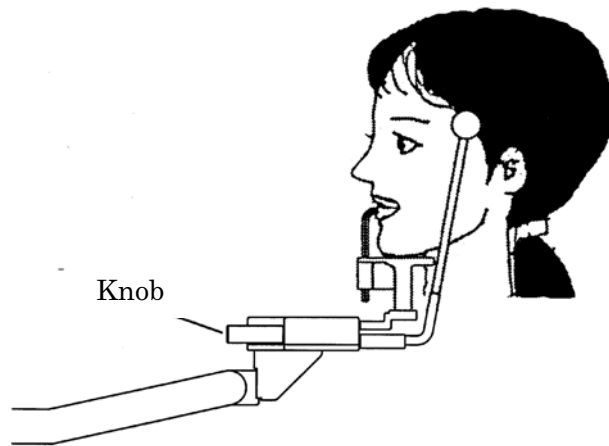

4. 11. Turn Positioning Beams ON

Depress any positioning beam switch to turn Patient Positioning Beams on.

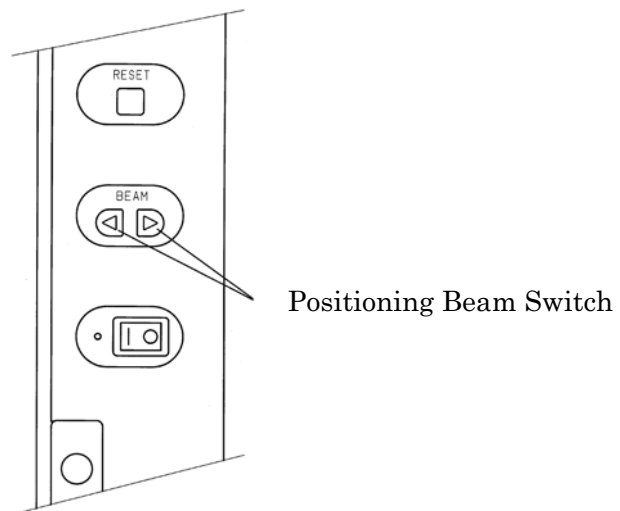

4. 12. Median Plane Beam, Frankfort Plane Beam & Focus Beam turn on at the same time.



Caution

1. Warn patient not to look directly at the laser beam line.
2. Do not set the beam line to patient's eyes.



Note

Positioning beams have AUTO POWER OFF function. Laser beam will be automatically turned off in 60 seconds after the beam is lit ON, or under READY ON condition.

In order to turn the laser on, depress "Forward Movement" key or "Backward Movement" key.

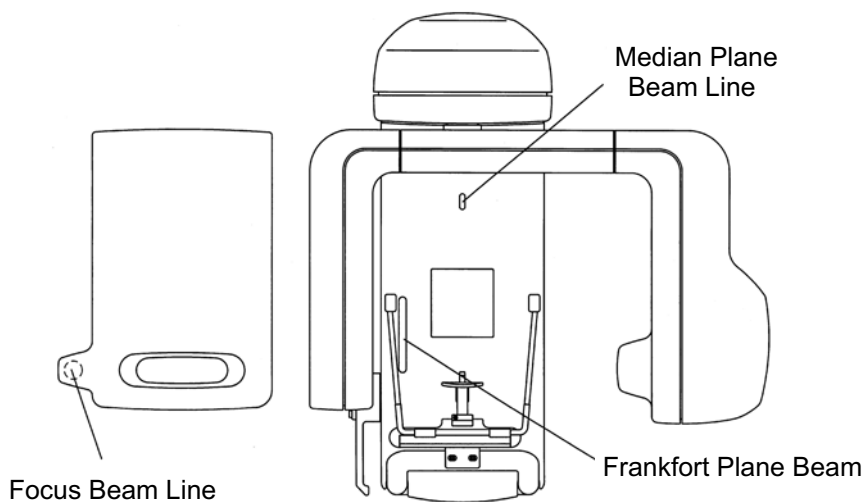

4. 13. Adjust the patient's head so that the Median Line Beam comes to the center of the patient's face,

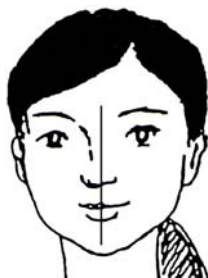

4. 14. Move Frankfort Beam to align Frankfort Beam Line with Frankfort Plane of a patient

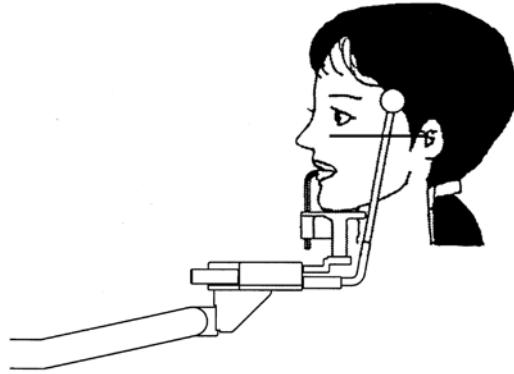

4. 15. Carefully close Head Holding Rods to support the patient's head.

4. 16. Align Focus Beam Line with roots of upper and lower anterior teeth.

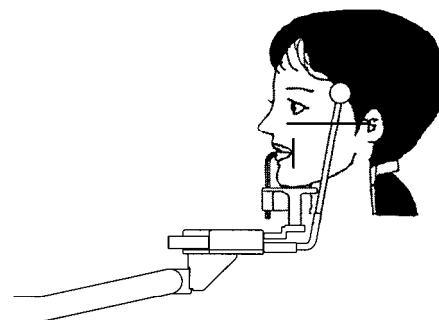
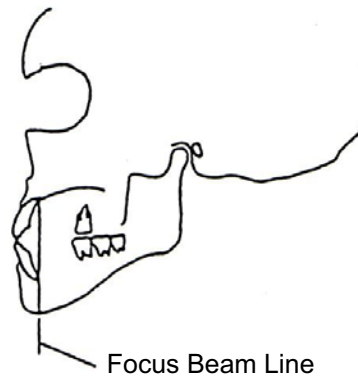

For an edentulous patient
Roll clean gauze on Bite Fork, and instruct patient to bite it.

4. 17. When you align the Focus Beam Line, look at patient from the side.

5. Ready On

Click Ready



Green Outer Frame of 「READY」 icon is flashed, 「initialization of sensor」 is displayed while CCD sensor is initiated.



After finish initialization of sensor, Outer Frame of 「READY」 icon changes to dark green, then 「Start exposure」 is displayed.



Note

1. After Start Exposure is displayed, If Exposure switch is not depressed within 30 seconds, Read On will be cancelled automatically.
2. Any key operation except Reset key cannot be operated during Ready On. To cancel Ready On, Hit Reset key.
3. If Arm is not at starting position, even if ready key is depressed, Read On won't come up. Hit Reset key to bring the Arm to the starting position.

6. X-Ray Irradiation



Warning

1. Other people except patient and operator should be outside of X-ray room.
2. The X-ray exposure switch should be depressed 7 feet away from Bel-Cypher. Operator must stand behind the shielded partition.
3. Carefully observe patient while X-ray is irradiated, release an Exposure switch immediately when any trouble happens.
4. Instruct patient not to move while X-ray is irradiated.



Warning

1. The exposure switch is deadman type. X-ray irradiation and the movement of the Rotation Unit will stop immediately when the exposure switch is released.
Keep the exposure switch depressed until the exposure is completely finished (indicated by a final beep then silence).
If you release the exposure switch before the completion of the exposure, you'll lose the image.
2. If exposure switch is released while X-ray is irradiated, release a patient and depress Reset key to bring Rotation Unit to the start position. Start from the beginning again.

6. 1. Keep on depressing Exposure Switch till the end of Exposure.

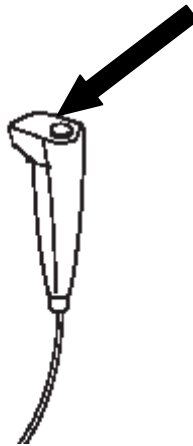

6. 2. Arm start to rotate, and X-ray irradiation starts with intermittent noise.
6. 3. While X-Ray is irradiated, "X-Ray ON" blinks on the PC display, and buzzer keeps on sounding intermittently.
6. 4. When irradiation is completed, arm rotation stops and buzzer stops sounding.

6. 5. "Transferring Data" is displayed on the PC Screen.



Caution

While data is transferring, do not turn off the power of Bel-Cypher, data will be lost.

6. 6. After data is transferred, Panoramic Image is displayed on the screen.

6. 7. Save an Image as needed.

7. Cooling Time

7. 1. When X-Ray Irradiation is completed, Bel-Cypher automatically goes into cooling phase. Remaining cooling time is displayed on the screen.



Caution

1. X-ray cannot be irradiated during COOLING TIME.
2. Any key operation excepting Reset key cannot be operated during COOLING TIME.
3. Do not turn power OFF until end of COOLING TIME.
4. When thermal error occurs, wait for 20 minutes before making another X-ray exposure.

8. Release of Patient

Carefully open Head Holding Rods then release a patient.

9. Bring Rotation Unit to the Start Position

By depress Reset key on the sliding unit, Rotation arm moves to starting position.

Caution

By hitting Reset Key, Arm starts to rotate. Stay away from Rotation area to avoid injury.

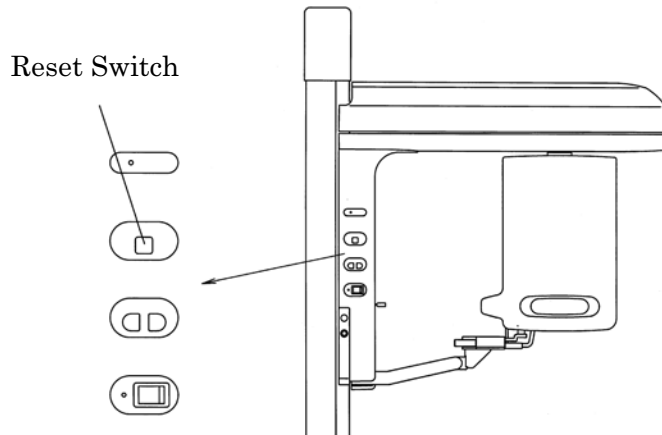

10. Turning Power OFF

10. 1. Confirm cooling time is completed.
10. 2. Confirm Panoramic Image is displayed on the PC Screen.
10. 3. Depress "O" key on POWER switch to turn the power off.

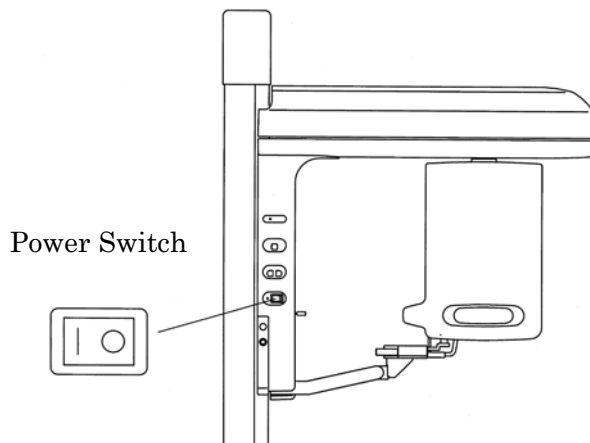

Caution

To prevent the risk of accident, turn the power switch off when the unit is not in use.

When Bel-cypher is idle for more than 10 minutes, the unit will stop supplying power besides to switching power supply (Power-off mode) and beeps.

At the Power-off mode, If you start TWAIN Program, "Communication Error" occurs.

If you don't use Bel-Cypher for more than 10 minutes, please shut the power switch off.

12. Operation Procedure for TMJ

1. Preparation for exposure

1. 1.

- * X ray protective clothing
- * Ear Rods for TMJ

1. 2. Attach Ear Rods to Chinrest Section

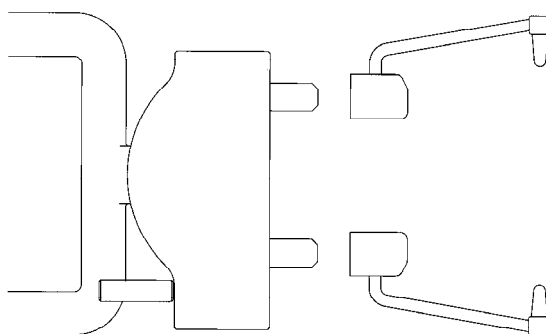

2. Turn the Power of Bel-Cypher

1. Push "I" on the power switch to turn the power ON.

3. Exposure settings



Click either "Import" or "Scan" from diagnostic software / imaging software.

Check Power



If the power of the equipment is ON, click OK.

Reset



If you error message 「Equipment is not at the original position」 comes up,

Click RESET button.

Choose Exposure Mode



Choose TMJ Mode
Selected mode will be highlighted.

kV and mA settings

Refer Sec 13 Table of Exposure Settings to choose appropriate setting values



Set kV
Click either ▲(up) or ▼(down) to set appropriate value.

Set mA
Click either ▲(up) or ▼(down) to set appropriate value.

Or simply click patient size icon.
You may need to adjust mA / kV on some patients.

4. Patient Positioning

4.1 By Turning adjuster Knob, open Ear Rods

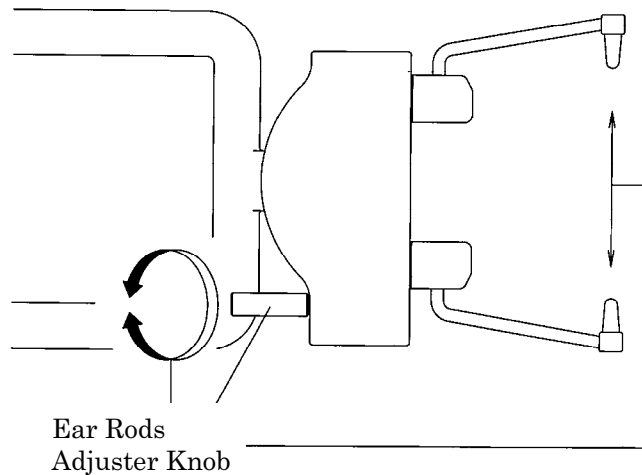

4. 2. Put X-ray protector apron on patient and the assistant



Caution

Please make sure to put X-ray protector apron on patient and the assistant

4. 3. Bring a patient close to Bel-Cypher.

4. 4. Adjust the height of Chinrest by moving Overhead Carriage up/down, so that the patient can stand upright and align ear rods to patient's external auditory foramen.



Caution

By depressing Electro –Magnetic Lock Switch, magnetic lock is released.

While moving Overhead Carriage, be careful not to hit patient by Overhead Carriage.

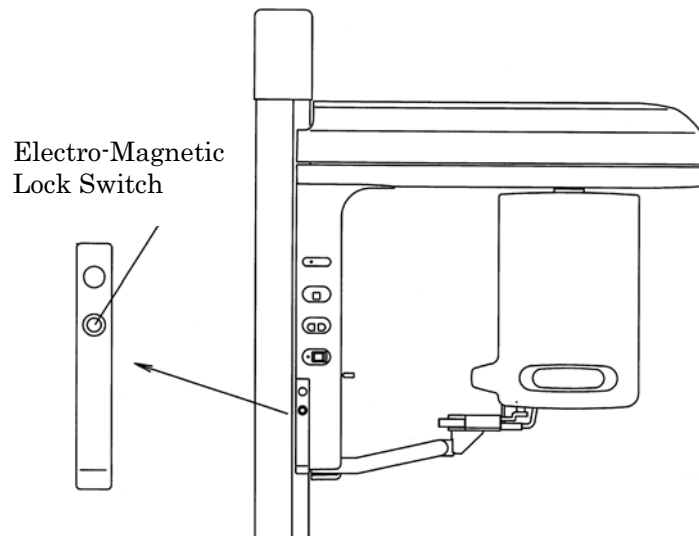

4. 5. Bring patient to stand on below foot position.

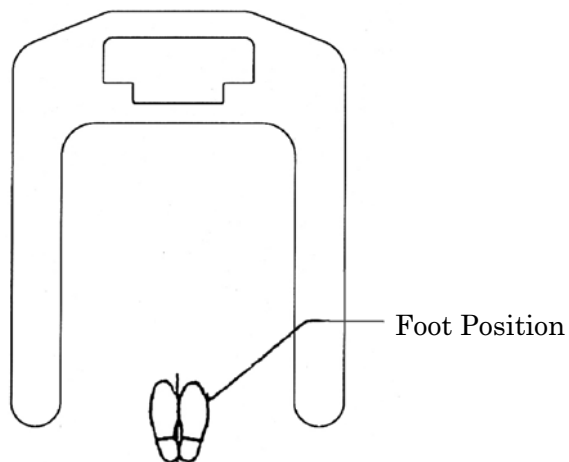

4. 6. Ask patient to hold grips
4. 7. Adjust the height of Chinrest by moving Overhead Carriage up/down, align ear rods to patient's external auditory foramen.



Caution

By depressing Electro –Magnetic Lock Switch, magnetic lock is released.

While moving Overhead Carriage, be careful not to hit patient by Overhead Carriage.

4. 8. Rotate the knob of the Chinrest ASSY to insert Ear Rod into auricular holes of a patient and fix Ear Rod lightly.

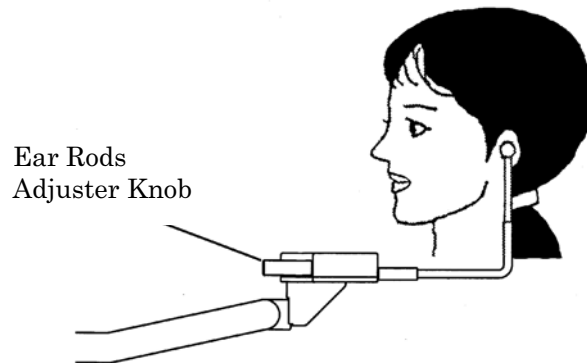

4. 9. Turn Positioning Beams ON
Depress any positioning beam switch to turn Patient Positioning Beams on.

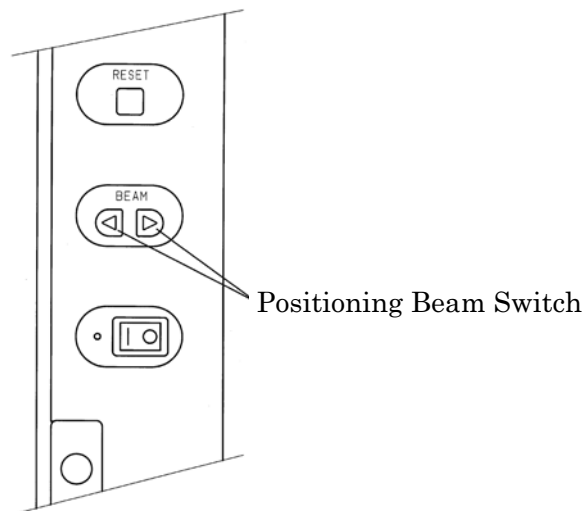

4. 10. Median Plane Beam, Frankfort Plane Beam & Focus Beam turn on at the same time

⚠ Caution

1. Warn patient not to look directly at the laser beam line.
2. Do not set the beam line to patient's eyes.

👉 Note

Positioning beams have AUTO POWER OFF function. Laser beam will be automatically turned off in 60 seconds after the beam is lit ON, or under READY ON condition.
In order to turn the laser on, depress "Forward Movement" key or "Backward Movement" key

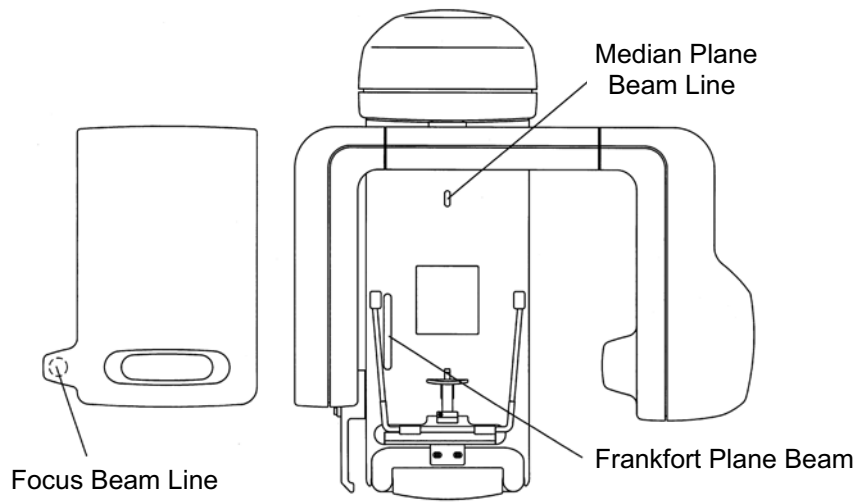

4. 11. Horizontally align to the patient's naso-auricularplane

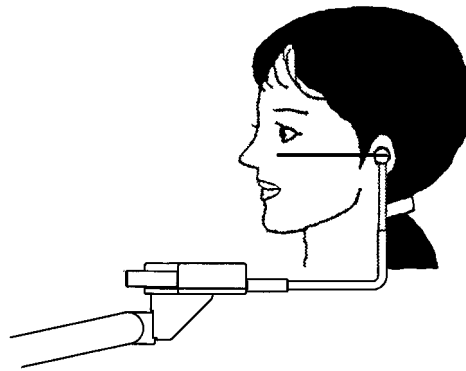

4. 12. Rotate the knob of the Chinrest ASSY to insert Ear Rod into auricular holes of a patient and fix Ear Rod lightly.

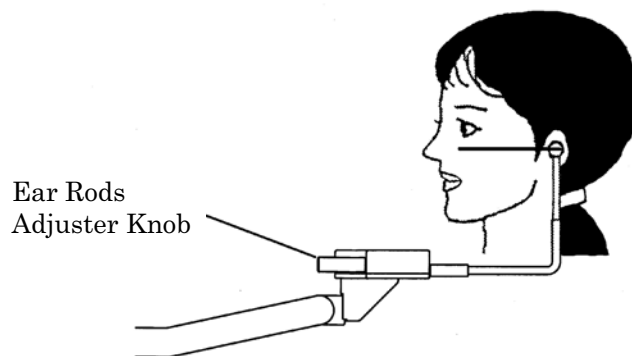

5. Ready On

Please refer 5 Ready On of Panoramic Procedures

6. X-Ray Irradiation

Warning

1. Other people except patient and operator should be outside of X-ray room.
2. The X-ray exposure switch should be depressed 7 feet away from Bel-Cypher. Operator must stand behind the shielded partition.
3. Carefully observe patient while X-ray is irradiated, release an Exposure switch immediately when any trouble happens.
4. Instruct patient not to move while X-ray is irradiated.

Note

1. The exposure switch is deadman type. X-ray irradiation and the movement of the Rotation Unit will stop immediately when the exposure switch is released.
2. If exposure switch is released while X-ray is irradiated, release a patient and depress Reset key to bring Rotation Unit to the start position. Start from the beginning again.

6. 1. TMJ Lateral 4 sections consist of a series of two exposures. 1st exposure for the diagnosis of TMJ with mouth closed and 2nd exposure for TMJ with mouse open.

6. 2. Ask patient to close the mouth

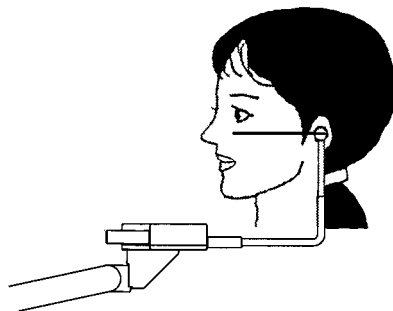

6. 3. Depress the exposure switch and hold until the end of exposure

6. 4. The Rotation Unit starts to rotate, X-RAY is indicated on indicator, and buzzer starts to sound intermittently.

6. 5. 1 After the end of the first exposure, X-RAY indication display is turned OFF, an audible warning stops, the Rotation Unit stops to rotate, then returns to the start position automatically

6. 6. Ask patient to open mouth by lowering mandible

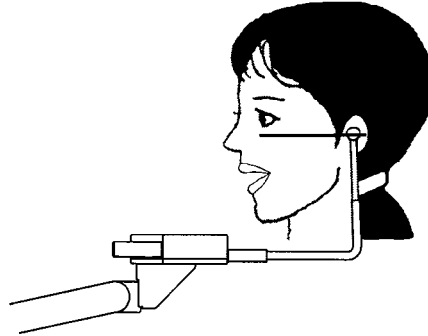

6. 7. Depress "READY" key to get into READY ON condition

6. 8. Depress exposure switch and hold until the end of exposure

6. 9. The Rotation Unit starts to rotate, X-RAY is indicated on indicator, and buzzer starts to sound intermittently.

6. 10. X-RAY keeps to be indicated and buzzer keeps to sound

6. 11. After 2nd exposure is finished, X-RAY will be lighted OFF, and buzzer will stop to sound and ARM Unit will stop to rotate.

6. 12. "Transferring Data" is displayed on the PC screen



Caution

While data is transferring, do not turn off the power of Bel-Cypher, data will be lost.

6. 13. After data is transferred, TMJ Images are displayed on the screen

6. 14. Save Images as needed.

7. Cooling Time

7. 1. When X-Ray Irradiation is completed, Bel-Cypher automatically goes into cooling phase.
Remaining cooling time is displayed on the screen.



Caution

1. X-ray cannot be irradiated during COOLING TIME.
2. Any key operation excepting Reset key cannot be operated during COOLING TIME.
3. Do not turn power OFF until end of COOLING TIME.

8. Release of Patient

Carefully open Head Holding Rods then release a patient.

9. Bring Rotation Unit to the Start Position

By depress Reset key on the sliding unit, Rotation arm moves to starting position.



Caution

By hitting Reset Key, Arm starts to rotate. Stay away from Rotation area to avoid injury.

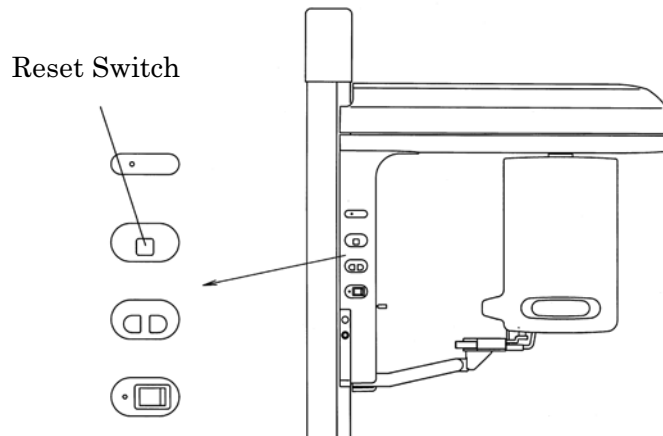

10. Turning Power OFF

10. 1. Confirm cooling time is completed.
10. 2. Confirm Panoramic Image is displayed on the PC Screen.
10. 3. Depress "O" key on POWER switch to turn the power off.



Caution

To prevent the risk of accident, turn the power switch off when the unit is not in use

13. Table of Exposure Settings

1. Panorama & Panoramic Bitewing

Panorama Child : CHILD ORBIT (P A N O R A M A : S)

| AGE | SEX | kV | mA | Sec |
|--------|-----|----|----|-----|
| 5 ~ 11 | — | 60 | 8 | 10 |

Panorama Adult : ADULT ORBIT (P A N O R A M A : N)

| AGE | SEX | kV | mA | Sec |
|---------|----------|---------|----|-----|
| 12 ~ 15 | — | 60 | 8 | 10 |
| Adult | Female S | 60 ~ 63 | 8 | 10 |
| | M/F | 63 ~ 66 | 8 | 10 |
| | Male L | 66 ~ 80 | 8 | 10 |

2. TMJ

TMJ Lateral (4 sections)

| AGE | SEX | kV | mA | Sec |
|--------|----------|---------|----|-------------|
| 5 ~ 15 | — | 60 | 8 | 2.5Sec (X4) |
| Adult | Female S | 60 ~ 63 | 8 | 2.5Sec (X4) |
| | M/F | 63 ~ 66 | 8 | 2.5Sec (X4) |
| | Male L | 66 ~ 80 | 8 | 2.5Sec (X4) |

Set exposure factors by considering the size, age, bone density, etc. of the patient.

1 4 . Magnification of Image

| Radiographic Mode | | Magnification |
|-------------------|-------------|---------------|
| PANORAMA | Child Orbit | 1.23~1.34 |
| PANORAMA | Adult Orbit | 1.2 ~1.32 |
| TMJ Lateral | | 1.22~1.24 |

1 5 . DAILY MAINTENANCE

Cleaning and Disinfection

| Parts | How to maintenance |
|---------------------------------------|--|
| Bite Blocks (For Panorama) | Sterilize by AUTO-CLAVE after exposure(s) of each patient. Make enough disinfection with alcohol for medical use, of which alcohol degree is over 76%. after exposure of each patient |
| Head Holding Rods | |
| Ear Rods (TMJ Lateral 4 sections) | |
| Chinrest (Panorama) | |
| All other parts which patients touch. | |
| All other parts which operator touch. | Make enough disinfection with alcohol for medical use, of which alcohol degree is over 76%, at end of daily operation. |
| Outside cover of the equipment | Wipe equipment with a dry cloth at end of daily operation. |

1 6 . Trouble Shooting

1. POWER can not be turned ON

| Check | Treatment |
|------------------------------------|---------------------|
| Is breaker turned on? | Turn breaker on. |
| Is power plug connected to outlet? | Connect power plug. |

2. READY can not be turned on

| Check | Treatment |
|--|--------------------|
| Is positioning of ARM at starting place? | Depress RESET key. |

3. Error message on PC display

Treat by following message on display.

| Display |
|---|
| Invertor error. Depress RESET button. Cooling time is 20 minutes. |
| X-Ray Tube temperature error. Depress RESET button. Cooling time is 20 minutes. |
| Motor of Y axis error. Depress RESET button |
| Motor of rotation error. Depress RESET button |
| X-ray SW error. Depress RESET button |
| Communication error between MAIN CPU-MOTOR and CPU. Depress RESET button |
| Communication error between PC and MAIN CPU. Depress RESET button |

If you can not solve problem by treatment of following display, turn off the power and turn on the power again.

- * When the trouble cannot be resolved, turn power of the equipment OFF, and remove electric power socket from electric outlet, and call our agent or our office which is near you.

17. X-Ray Tube Focus, Sensor Location, Collimator & Exposure Field

X-Ray Tube Focus and Sensor Location

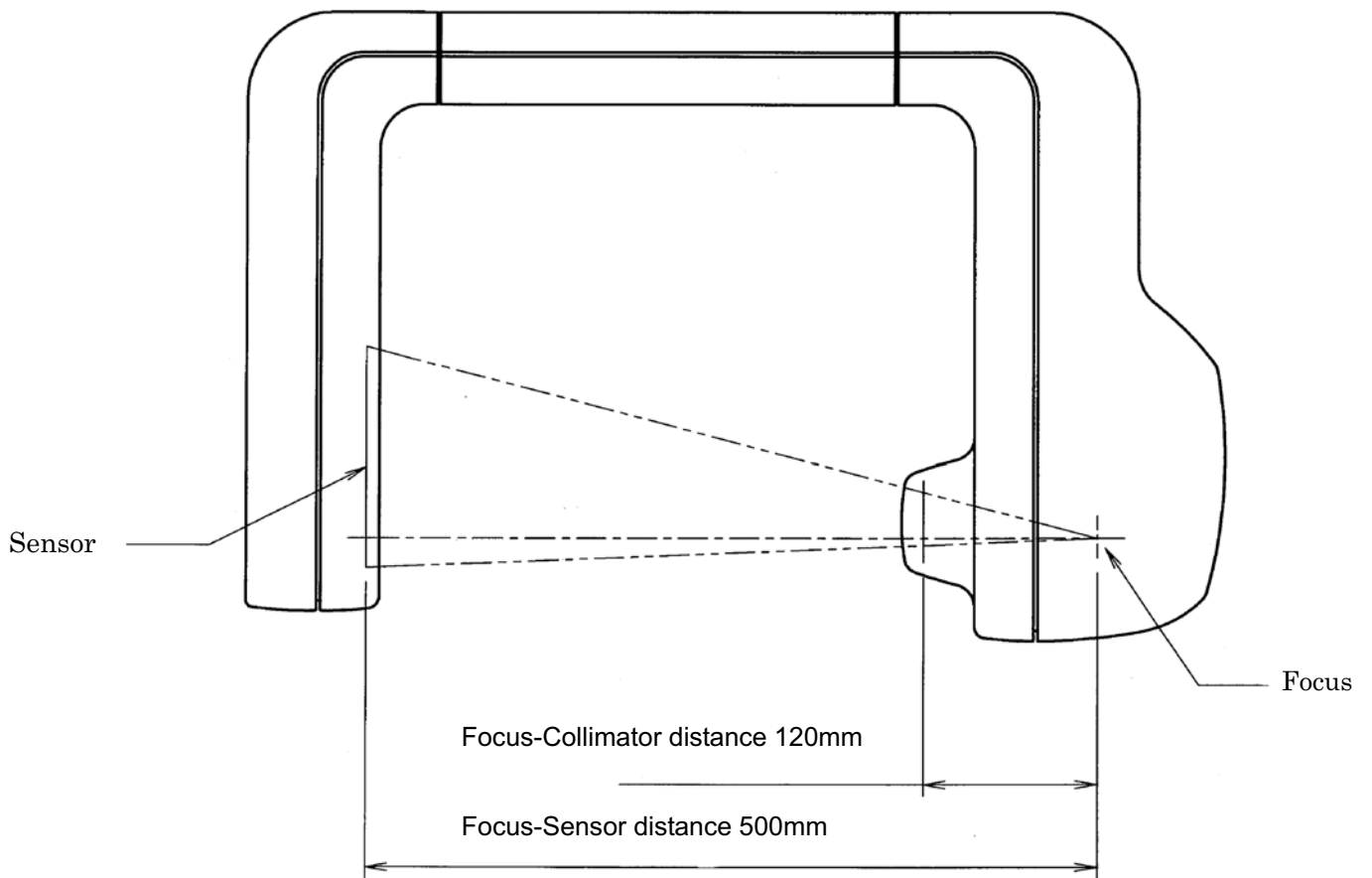

Collimator and Exposure Field

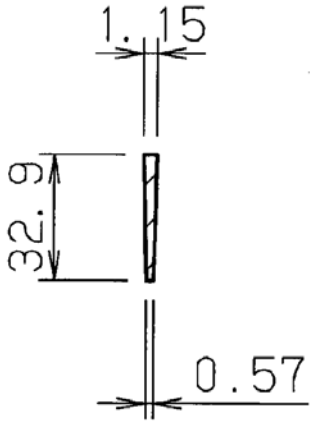
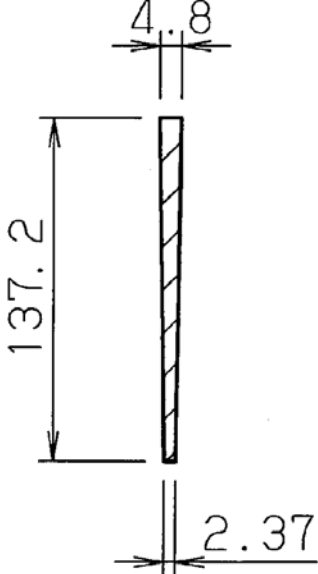
| Shape of Collimator | Exposure Field |
|---|---|
|  <p>A diagram of a rectangular collimator. It is a vertical rectangle with a height of 32.9, a width of 1.15, and a depth of 0.57. The top and bottom edges are indicated by double parallel lines.</p> |  <p>A diagram of an exposure field. It is a vertical rectangle with a height of 137.2, a width of 4.8, and a depth of 2.37. The top and bottom edges are indicated by double parallel lines.</p> |

18. Physical Dimensions

Dimension of equipment (with Free Standing Base)

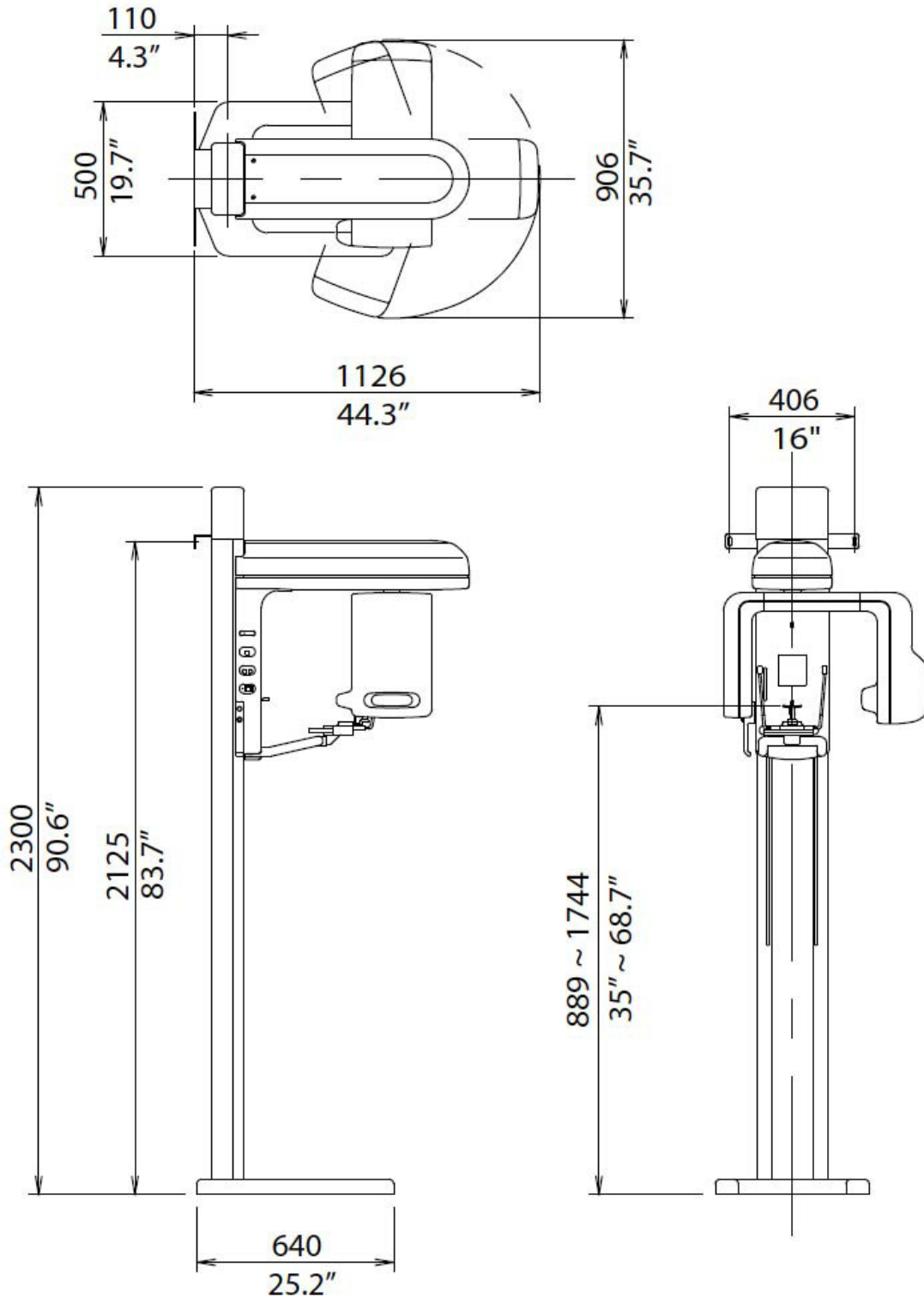

Dimension of equipment (without Free Standing Base)

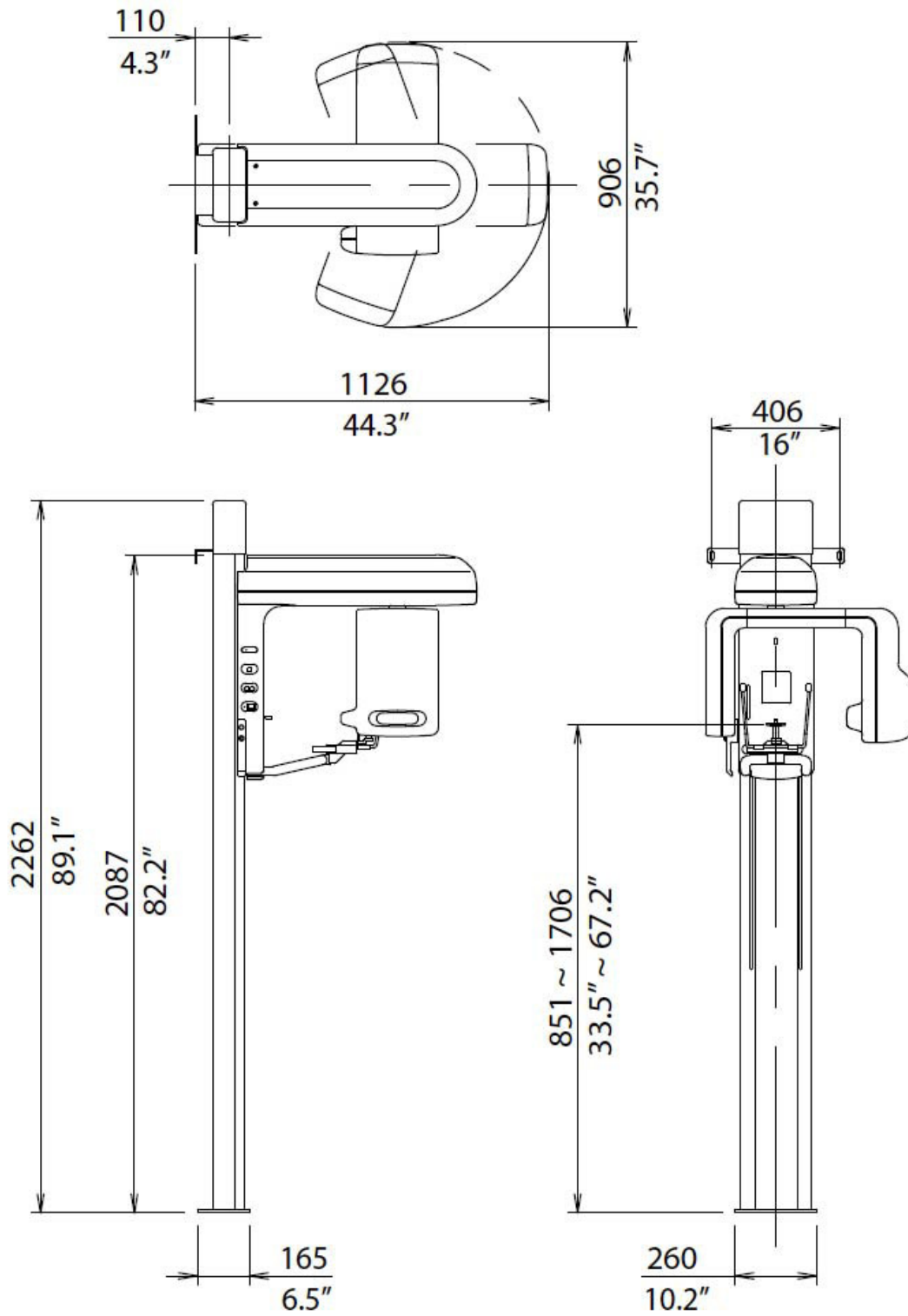

19. Labels

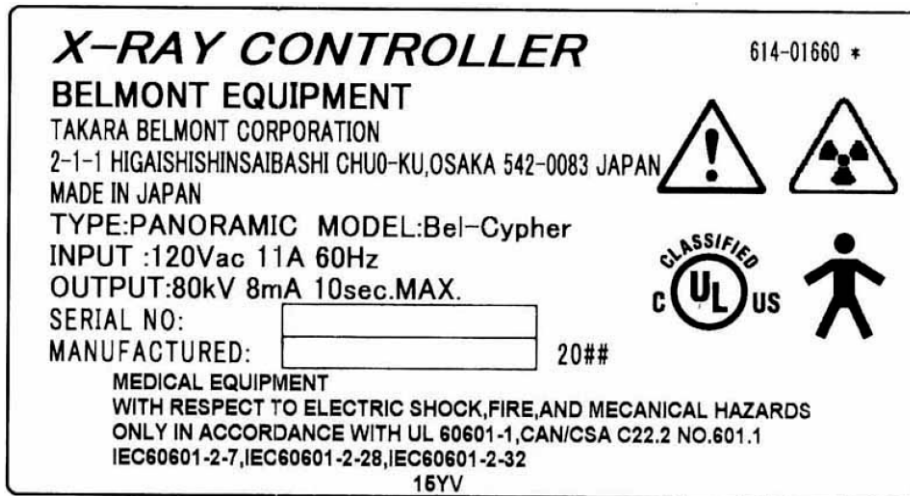

- | | |
|---|-----------------------|
| 1: Indication of Distributor | 7: Manufacturing Date |
| 2: Model Name | 8: Serial Number |
| 3: Attention, consult Accompanying Document | 9: Supply Frequency |
| 4: DWG. No. | 10: Power |
| 5: Ionizing Radiation | 11: Supply Voltage |
| 6: TYPE B Applied Part | |

X-RAY HEAD

614-01661 *

BELMONT EQUIPMENT

TAKARA BELMONT CORPORATION

2-1-1 HIGASHISHINSAIBASHI CHUO-KU, OSAKA 542-0083 JAPAN

MADE IN JAPAN

TYPE: PANORAMIC MODEL: Bel-Cypher

OUTPUT: 80kV 8mA 10sec MAX. COOLING TIME: 90sec

TUBE VOLTAGE: 100kV MAX

TUBE: MODEL D-052SB NO. TOSHIBA CORP.

TOTAL FILTRATION: 2.8mmAL (min) ADDED FILTRATION: 1.5mmAL

SERIAL NO: FOCUS: 0.5mm

MANUFACTURED: 20##

MANUFACTURER: ASAHI ROENTGEN IND.CO.,LTD.

376-3 Tsukiyama-cho,kuze

Minami-ku,Kyoto 601-8203,Japan

1: Indication of Distributor

2: Model Name

3: DWG. No.

4: Added Filtration

5: Focus Size

6: Tube Number

7: Indication of Origin

8: Manufacturing Date

9: Serial Number

10: Total Filtration

11: X-ray Tube Type

12: Maximum X-ray Rated

20. Technical Data

1. International standards

- IEC 60601-2-7 (1998)
- IEC 60601-2-7-28 (1993-03)
- IEC 60601-2-7-32 (1994-03)
- IEC 60601-1-4 (2000-04)

2. Equipment classification

- 1 . According to the type of protection against electric shock
 - a) Equipment energized from external electrical power source.
Class I equipment
- 2 . According to the degree of protection against electric shock
Type B applied part
Protection against Ingress of water
Ordinary
Equipment not suitable for use in the presence of a FLAMMABLE ANAESTHETIC MIXTURE WITH AIR OR WITH OXYGEN OR NITROUS OXIDE
- 3 . According to the mode of operation:
Continuous Operation with Short-Time Loading, Cooling Time: 90sec

3. Environment condition

- Temperature: 5-35°C
- Humidity: 30-85%
- Atmospheric pressure: 700-1060 hPa

4. Storage condition

- Temperature: -10-60°C
- Humidity: 30-85%
- Atmospheric pressure: 700-1060 hPa

5. X-ray generator data

1. Maximum electric output
 - Maximum tube voltage: 60-80 kV
 - Maximum tube current: 2-8 mA
2. Nominal maximum electric power output
 - 80 kV, 8 mA
 - 640 W
3. Maximum product of current and time
 - 80 mAs (8 mA,10 sec)

4. Minimum product of current and time
20 mAs (2 ma, 2.5 sec x 4 exposures)
5. Nominal anode input capacity
1750 W
6. Maximum anode heat capacity
35 kJ (50 kHU)
7. Target material
Tungsten (W)
8. Target angle (anode inclination)
5°
9. Focal spot
0.5 (mm)
10. X-ray inherent filtration
Minimum 0.8 mm Al

11. Nominal X-ray tube voltage
50-100 kV
12. X-ray tube filament rating
3.5-4.9 V 3.5 A
13. Generator weight
Approx. 14.7 kg
14. Generator type
Class I
15. Standard assembling angle of X-ray generator
Horizontal/Perpendicular
16. Target angle of assembling X-ray generator
5°
17. Accuracy of X-ray tube (focal spot) assembled into X-ray generator
±0.5 mm
18. Focal spot when assembled into X-ray generator
0.5 mm
19. Duty cycle
Cooling time: 300 sec (Every four times)

6. Aluminum (Filter material)

Part name: filter

Aluminum equivalent amount: 1.5 mm Al

7. Power supply impedance

0.3 Ω

21. MAINTENANCE

Warning

**High voltage is applied to inside of the equipment. Do not open the cover by yourself.
Before asking for a repair, turn the power of the equipment OFF, and unplug from the power outlet.
After you unplug the equipment, wait for 10 minutes before starting a service work.**

Special knowledge and special measuring tools are required to check this equipment.

To ensure that X-ray unit functions within the manufacturer's specifications and remains in compliance with Standards, daily checking (by eyes) and a periodic maintenance by the dealer service personnel are recommended.

Maintenance by service personnel 1-2 times/year

| Check Item | Purpose | Action | Method |
|------------------------------------|--|--|--------|
| Electricity Condition | Check voltage range | Check whether incoming voltage is within the equipment's requirement or not. | ● |
| External Appearance | External Appearance | A) Deformation, scratches. | ⊙ |
| | | B) Warning Labels | ⊙ |
| | Inside of the equipment | Check stain and dust | ● |
| Installation place | Temperature & Humidity | Check compatibility of the environmental conditions to operate the equipment | ● |
| | Level of floor | Check the influence to the equipment | ● |
| | The Installation condition of the equipment | Check vibration and movement stability of the equipment | ● |
| | Check obstacles | Make sure that there are no obstacles within the movement range of the equipment | ⊙ |
| | Rust | Check the condition of the rust. Evaluate the influence to the safety. | ⊙ |
| Safety Test for Electric Shock | Insulation Resistance | Check the resistance between a power line and the earth | ● |
| | Leaked current from the outer cover | Check the current which is leaked from the outer cover of the equipment to the earth | ● |
| | Earthing resistance | Check the resistance value between an exposed metal and the earth | ● |
| | Resistance of the Earth wire | Resistance between the earth terminal and the earthing point | ● |
| Movement Accuracy of the equipment | Power Circuit voltage | Check the voltage of the power circuit | ● |
| | Check Radiographic Circuit | Check the wave shape and the setting values of the radiographic circuit | ● |
| | Check Control Circuit | Check the movements of operating sequences | ● |
| | Accuracy of the Positioning Mechanism | Check the deterioration of the positioning mechanism | ● |
| | Check the Movement of the Protection Circuit | Check the setting values of the protection circuit. Check the movement of the protection circuit. | ● |
| | Check display circuit | Check the functions of display circuit | ● |

| Check Item | Purpose | Action | Method |
|----------------------------|---|---|--------|
| Display during an exposure | Check irradiation of X-ray and "X-RAY ON" display are in sync | Check this while X-ray is irradiated. | ⊙ |
| X-ray Generator | X-ray tube | Check the leakage of insulation oil | ⊙ |
| | Low voltage cables | Check wear, damage, tension, and twist | ⊙ |
| | Cone | Check looseness, transformation, and damage | ⊙ |
| | Filter | Check transformation and damage | ⊙ |
| | Slit Plate (Collimator) | Check off-alignment of exposure field. Confirm the exposure width | ● |
| Radiographic mechanism | Movement of the ROTATION ARM ASSY | Check slip, abnormal sound, and stopping accuracy | ⊙ |
| | Patient Positioning Mechanism | Play, looseness, operational performance, and safety | ⊙ |
| | Positioning beams | Check the brightness and the positioning accuracy | ⊙ |
| Sliding mechanism | Wire Rope | Check cut, check the wire is securely connected to the terminal | ● |
| | Upward / downward movements | Check smoothness of the movement | ⊙ |
| | Drop prevention mechanism | Check safety mechanism works properly | ● |
| X-ray output | X-ray Tube Voltage | Check X-ray Tube voltage | ● |
| | X-ray Tube Current | Check X-ray Tube current | ● |
| | Exposure Time | Check exposure time | ● |
| | | | |

Checking Methods

⊙ : Check by eyes during a daily operation

● : Check by a service personnel.

22. Contact Information

Belmont Equipment

A Division of TAKARA BELMONT USA, Inc.

101 Belmont Drive

Somerset, NJ 08873

Toll Free (800) 223-1192

Toll Free Fax (800) 280-7504

www.belmontequip.com

TAKARA COMPANY, CANADA, LTD.

2706 South Sheridan Way

Mississauga, Ontario, Canada L5J 2M4

Toll Free (800) 268-5351

Fax (905) 822-6203

www.takarabelmont.ca

23. Revision data of this manual

This manual was created on Oct 2008.
Revised on August 2010.

Document number : B02-T170