

PROIII 047
INSTRUCTIONS FOR USE

Dear Customers

Dear Customers

Thank you for purchasing our product.

This booklet explains how to use the PROIII 047.

Before using the PROIII 047, carefully read the operating instructions and use the product correctly.

Using the product without reading these instructions may lead to an accident.

For easy access to the information contained herein, keep this booklet at hand and review it as needed.

Ask your local authorized Belmont dealer to install this product, following the installation instructions contained in the product.

If you have any questions regarding the operating instructions or this product, contact your local authorized Belmont dealer.

If you find any dirt on or damage to the booklet and need a new one, report the catalog number indicated below to your local authorized Belmont dealer to order a new one.

2019-07	(4th Edition)
REF	1E0795DE

Dear Customers	2
----------------------	---

Introduction

General Information	4
Symbols	5
Risk Level Interpretation	6
Safety Precautions	7
Operating Precautions	14
Precautions when handling Synthetic Leather	15
Accessories	16
Major Components	17

Preparation

Power Supply	18
--------------------	----

How to use

Rotating the Chair	19
Adjust the Position of the Headrest	20
Operation of Seat and Backrest (Manual Operation)	21
Moving the Chair to Preset Positions (Automatic Operation)	22
Operating the Legrest	24
Armrest Rotation	25
Pinching Prevention	26

Care and Maintenance

Cleaning Procedures	27
---------------------------	----

When Necessary

Troubleshooting	28
Maintanance and Inspection	29
Environmental Conditions for Transportation or Packaging	31
Storing Method	31
Service Life	31
Consumable Parts	31
Electromagnetic Compatibility	32
Specifications	35

Intended Use of the Product

This product is an active therapeutic device intended for the exclusive use for diagnoses, treatments and relative procedures of dentistry. The product must be operated or handled by the qualified dentists or by dental staffs under the supervision of the dentist. Such dentists or dental staffs should instruct and/or assist the patients to approach to and leave from the product. Patients should not be allowed to operate or handle the product unless he/she is so instructed.

How to Dispose of the Device

When disposing of this product and parts replaced, carefully take infection control measures and handle them properly in accordance with the relevant laws and regulations (applicable regulations and local regulations).



















Technical Description

The following are explained in the documents listed below:

Item	Document
How to install this product	Installation Instructions
Wiring/plumbing	Installation Instructions

Symbols

The symbols listed below are used on the product, on labeling, and in this booklet. Check the meaning of each symbol.

	Switch (ON)		Switch (OFF)		Stick switch for automatic operation of chair		Stick switch for manual operation of chair
	Alternating current		Protective earthing		Non-ionizing radiation		Name and address of the manufacturer
	Year of manufacture		Catalog number		Basic precaution, unspecified		General warning, unspecified
	Type B Applied Parts contacting the patient's body surface only		Follow instructions for use		Generally prohibited activity		Disassembly, repair or modification prohibited
	Instructions for mandatory actions in general		Indicates that the power plug must be removed from the socket				

Risk Level Interpretation

Precautions before use

Make sure to carefully read the Safety Precautions and Operating Precautions and use the product correctly.

These precautions are intended to ensure the safe use of the product and prevent harm or damage to users or other people.

According to the magnitude of harm and damage and the degree of urgency, an incident that may be caused by misuse of the product is classified into one of the following categories: CONTRAINDICATION, WARNING, and CAUTION.

All of these categories are important for safety. Always follow the instructions provided.

We assume no responsibility for any accident due to failure to follow the Safety Precautions or Operating Precautions even in the event of harm or damage to users or other persons.

In such case, users or other persons who use the product without observing the Safety Precautions and Operating Precautions are responsible for any harm or damage incurred.

The graphical symbols are explained in detail below.

Once you have fully understood this explanation, read the text.

Classification by degree of harm or damage and urgency

CONTRAINDICATION

Use of the product without regard to this indication will create a hazardous condition that may result in death or serious injury.

WARNING

Improper handling of the product without regard to this indication will create a hazardous condition that may result in death or serious injury.

CAUTION

Improper handling of the product without regard to this indication will create a potentially hazardous condition that may result in moderate or slight injury or property damage.

The following graphical symbols are used to explain your responsibilities for using the product safely:

Graphical symbols for prohibited activity



Generally prohibited activity



Disassembly, repair or modification prohibited

Graphical symbols for mandatory action



Instructions for mandatory actions in general



Indicates that the power plug must be removed from the socket.

CONTRAINDICATION

Installing or transferring the product



Installation precautions

Do not install the chair near equipment that generates electromagnetic waves such as communication equipment and elevators. Doing so can result in faulty operation.

Use and maintenance of the product



Do not use the product for any purposes other than dental diagnosis and treatment.

This product is designed for dental diagnosis and treatment. This product must only be operated by dentists or dental staff performing dental procedures.

Precautions when using in the presence of electromagnetic interference waves.

Do not use devices that generate electromagnetic waves (such as mobile telephones) near this chair. Doing so can result in faulty operation.



Do not disassemble, repair or modify the chair.

Disassembly or repair must only be done by a qualified service staff. Disassembly by yourself can result in an accident, a malfunction, electric shock or fire.

Never modify the product. Doing so is dangerous.



When using a high-frequency surgical equipment, turn off the power switch for the product.

This product may cause a malfunction due to noise.

WARNING

Power Plug and Cord



Do not connect the earth (ground) to the following objects.

- Water pipes
(Complete grounding is not possible as hard plastic pipes are widely used.)
- Gas pipes (Can result in an explosion or fire)
- Lightning rods and telephone dedicated grounding wire (Dangerous during lightning)

Do not touch the power plug or socket with wet hands.

Failure to do so can result in electric shock.



Use a single socket (do not share a socket with other plugs).

Use an unshared socket with an attached ground terminal.

Using the same socket together with the power plug of other devices can result in abnormal heat generation and possible fire.

Firmly insert the power plug into the socket.

Be sure to fully insert the power plug into the socket until reaching the base of the plug.

Failure to fully insert the plug or similar fault can result in a short circuit or heat generation that causes a fire.

Wipe off the dirt on power plug and socket with a dry cloth to avoid any possible fire.

Hold by the power plug when unplugging.

Do not pull the cord to remove the power plug from the socket. Hold by the power plug at the end of the cord when removing. Removing the plug by pulling the power cord can damage the power cord, resulting in electric shock or fire.

Be careful when handling the power cord.

Damaging the cord can result in electric shock or fire.

- Do not damage the cord.
- Do not place objects on top of the cord.
- Do not alter the cord.
- Do not heat the cord.
- Do not excessively bend, twist, or pull the cord.

Be careful of power cord or plug breakage.

Do not use any power cord or plug that is damaged, or that fits loosely when inserted into a socket. Doing so can result in electric shock or fire.

WARNING

Power Plug and Cord



Securely connect to ground.

Failure to make a ground connection can result in electric shock if there is a malfunction or short circuit. Consult an electrician for grounding procedures.

Unplug the power plug when the chair is not in use.

Turn off the power switch and remove the power plug from the socket when the chair is not in use. Unexpected operation can result in an accident or fire from a short circuit due to insulation aging.

Installing or transferring the product



Installation precautions

Ask your local authorized Belmont dealer to install this product.

Make sure to place the product on a firm and flat floor. Placing the equipment on a tilted floor (5°) may cause it to fall.

Place no obstacles adjacent to the power socket for an easy access by the power plug.

Use and maintenance of the product



Keep moving parts of the product away from patients' and users' hands, fingers, and bodies.

Hands, fingers or bodies may become caught in the product, causing injury.

The patient must not lie on his/her stomach, kneel in the formal seiza position (with his/her buttocks on his/her heels), or sit on the product with a child in his/her arms.

The chair may move unexpectedly, causing injury.

The patient must not sit on the edge of the seat.

The chair may fall or move unexpectedly, causing injury or damage to peripheral devices.

The patient must not sit in an area other than the designated location.

Excessive load must not be applied to the product.

The patient must not sit on the headrest, armrest, backrest, or leg rest.

Excessive load must not be applied to these parts.

This may cause injury due to falling, or damage to peripheral devices.

Do not wash with water.

This may cause failure or electric shock.

WARNING

Use and Cleaning Precautions

Perform cleaning before using the product for the first time. This product is not sterilized or disinfected when shipped.



Precautions for when sitting the patient down

Sit the patient down so that their body does not extend beyond the product, as in the figure left.

When operating the product, check that the patient's posture remains as shown in the figure left.

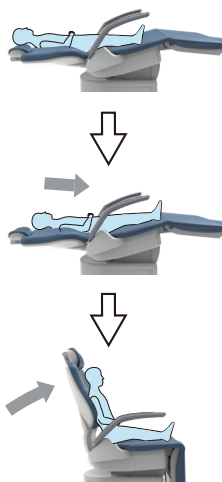
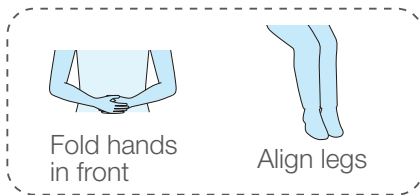

For small children, when raising the backrest, slide the child so that they are sitting on the seat section and ensure they are in correct posture.

Remove the patient's glasses and any accessories (such as a necklace or bracelets) before treatment.

Failure to follow this instruction may hamper treatment and lead to an accident.

Precautions when raising/lowering the backrest

Before lowering the backrest, ensure that the patient's arm or hand is not sandwiched between the backrest and the seat.

Before raising the backrest, ensure that the patient's arm or hand is not sandwiched between the backrest and the armrest.

If the backrest is lowered during automatic operation, the legrest will be raised. Operate the backrest carefully to prevent the patient's toes from contacting the peripheral devices.

If the backrest is raised during automatic operation, the legrest will be lowered. Operate the backrest carefully after ensuring that the space beneath the legrest is clear of people and objects.

Pay close attention to a patient who has a cardiac pacemaker or defibrillator implanted.

If any abnormality occurs, immediately turn off the power switch and discontinue use of the product.

The PROIII 047 may affect the function of the pacemaker or defibrillator, leading to an accident.

WARNING

Use and Cleaning Precautions



Precautions for getting on and off the PROIII 047

When the patient gets on or off the PROIII 047, the chair should always be at the lowest position with the backrest at upright position and with the rotation being locked by the lock pedal.

Before moving a patient from a wheelchair to the PROIII 047 or vice versa, ensure that no obstacles are situated around the wheelchair or the caregiver.

Contact of the feet or the wheelchair castors with obstacles may cause injury or damage to peripheral devices.

When the patient is moved from a wheelchair to the PROIII 047 or vice versa, he/she must be carefully monitored to prevent falling.

If the patient has to get off the PROIII 047 at a position other than the designated Entry/Exit position due to power failure or in the event of an emergency, he/she must be carefully monitored to prevent falling.

Pay attention to patients and children

Keep your eyes on the patient when this product is in use.

Patients (especially children) may touch the control switch or system inadvertently, leading to an accident due to incorrect operation of the product.

Keep children away from this product except when giving treatment.

Precautions for operating the chair

Before and during the chair operation, pay close attention to the operation range (seat raising/lowering direction, backrest lowering/raising direction, and legrest traveling direction), and ensure that the chair does not contact any body parts, hands or feet, or objects. Body parts, hands or feet, or objects may become caught in the chair, causing injury or damage to peripheral devices.

Before operating the chair, ensure that the patient is sitting in the correct position, and keep your eyes on him/her when the chair is in use.

Clean the product thoroughly

Poor cleaning may cause bacteria to grow, posing a health risk. See cleaning procedures on page 27.

Be sure to always perform maintenance and inspection.

Failure to perform maintenance and inspection can result in injury or damage. Refer to "Maintenance and Inspection" on p. 29-30.

WARNING

Use and Cleaning Precautions



Precautions during chair rotation

Make sure that no persons or objects are nearby before slowly rotating the chair.

Be careful of the patient when the backrest is reclined and check that the safety of the patient is ensured before rotating the chair.

Be sure to always lock (secure) chair rotation after rotating the chair.

Always be sure that rotation is locked before operating the product. Accidental rotation of the product can result in injuries or damage to nearby equipment / instruments.

Discontinue use of the product if it is broken.

In the case of a broken product, immediately discontinue use and turn off the power switch. Then, ask your local authorized Belmont dealer to repair the product.

California Proposition 65

Cancer and Reproductive Harm - www.P65Warnings.ca.gov.



Turn off the power switch and unplug the power plug before cleaning.

Failure to do so can result in electric shock or fire. Also, sudden movement of the chair while cleaning can result in injury.

Procedures if a power outage occurs

Turn off the power switch and remove the power plug of the product from the socket in order to prevent unexpected operation when recovering from a power outage.

Use and maintenance
of the product



CAUTION

Do not allow a person who exceeds the weight limit to sit on the chair.

Falling or operational failure may occur.

Do not hit or rub the product.

This may cause damage to the cover or operational failure.

Ensure that each part operates normally, with no abnormalities detected, before operation.

Always inspect the product for abnormal findings such as loose components, backlash, tilting, vibration, sound, abnormal temperature, or bad odors. If you feel something is wrong, immediately discontinue use of the product and turn off the power switch. Then, contact your local authorized Belmont dealer.

Be sure to operate switches manually.

Make sure to operate the switches manually, except for the stick switches operated by the foot. Failure to operate the switches by hand may cause damage or malfunction.

Carefully operate the switches to prevent a mistake.

The operator should pay close attention to people around the product and say something before operation to prevent any errors.

Precautions when using the headrest

During the headrest operation, ensure that your fingers do not become caught in the control lever and are not sandwiched between the headrest and the backrest.

Be careful that the power cord is not caught up by your feet or legs.

Failure to do so can result in injury.

Immediately wipe off any drug solutions or water adhered to the PROIII 047.

Adherence of drug solutions or water to the control unit may cause operational failure or electrical leak. If drug solutions or water are adhered, immediately turn off the power switch and wipe them off with a dry, soft cloth.

Precautions for cleaning procedures

The metal and mechanical parts of the chair have sharp edges. Be careful when cleaning the chair that your hands, fingers or other body parts are not injured.

Turn off the power switch at the closing time or during a break.

Malfunction due to contact with the PROIII 047 will cause damage or injury.

Safety Precautions

Caution points during operation of the product Description of symbol marks

- ➔ Caution areas such as moving parts, rotating parts and detachable parts to which caution should be paid.
- Caution areas that are provided with an emergency stop mechanism.

Description of attention areas



- 1 Pay attention to prevent body parts or objects from becoming caught in the headrest moving parts.
Ensure that fingers or hair do not become caught in the headrest moving parts.
- 2 Pay attention to prevent body parts or objects from becoming caught in the backrest moving parts.
Ensure that hands or feet are not sandwiched between the backrest and the seat.
- 3 Pay attention to prevent body parts or object from becoming caught in the armrest.
Do not operate the chair when the armrest is 180 degrees rotated.
- 4 Pay attention to prevent body parts or objects from becoming caught in the bottom of the seat.
Ensure that hands or feet are not placed in the bottom of the seat.
- 5 Pay attention to prevent body parts or objects from becoming caught in the bottom of the legrest.
Ensure that feet are not placed beneath the legrest.

Operating Precautions

Immediately wipe off any drug solutions adhered to the PROIII 047.

Otherwise, they may cause deterioration or discoloration.

Do not apply heat to this product.

This may cause deterioration or discoloration.

Discoloration of resin

Resin materials are used in external components of this product. Carefully selected materials are used; however, discoloration may occur for reasons such as natural deterioration or the adherence of drug solutions. To ensure use of the PROIII 047 for as long as possible, immediately wipe off any drug solutions adhered and avoid sunlight.

Do not place objects other than a human being on the seat.

This may cause deformation, tears, or corrosion of the leather.

Chair's weight limit

The chair may rise slowly if a person weighs around the weight limit.

Precautions when handling Synthetic Leather

Adherence of clothing dye

Dye may migrate from clothes or belts to the synthetic leathers of this product. If dye is adhered, wipe gently with a soft cloth impregnated with a neutral detergent diluted to about one-tenth with water as soon as possible to prevent penetration. Next, wipe with water and then thoroughly with a dry cloth.

Pay attention to prevent deterioration and dye migration due to contact.

Contact with other resin materials, coated products, solvents, and adhesive tapes may cause changes in the surface gloss, cracks, deformation or abrasion.

Dye may migrate from newspapers or printed matters to this product.

Dye may migrate from printed clothes such as T-shirts or denim clothes to the leathers of this product.

Adherence of benzene, nail polish remover, alcohol, or oil may cause discoloration, surface dissolution, changes in gloss, hardening, softening or abrasion.

Use of a bleaching agent or a sheet cleaned by bleach may cause changes in gloss or discoloration.

Placing the product near a heat source such as a heater may cause deformation or discoloration.

Shield the product from direct sunlight by using a curtain. Direct sunlight may cause surface change, shrinkage, discoloration or fading.

Placing a heavy object on the product for a long time may leave a mark or wrinkle.

Check that all the following accessories are present.
If anything is missing or damaged, contact your local authorized Belmont dealer.

- Instructions for use (this instruction)
- Installation Instructions

Major Components

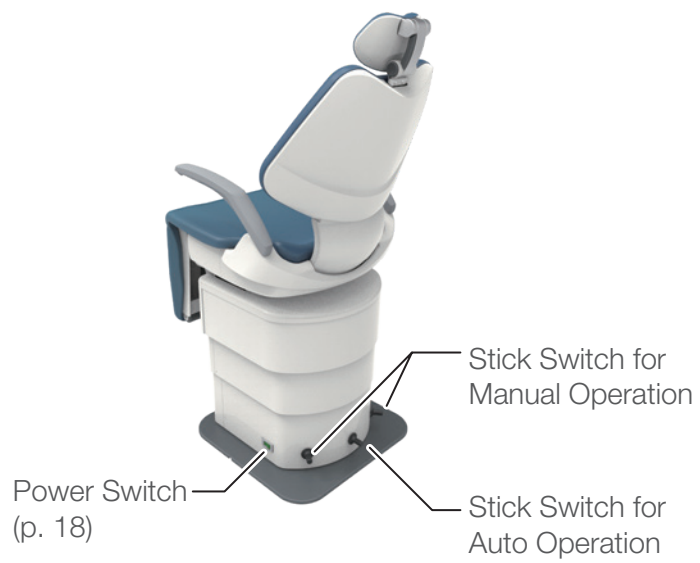
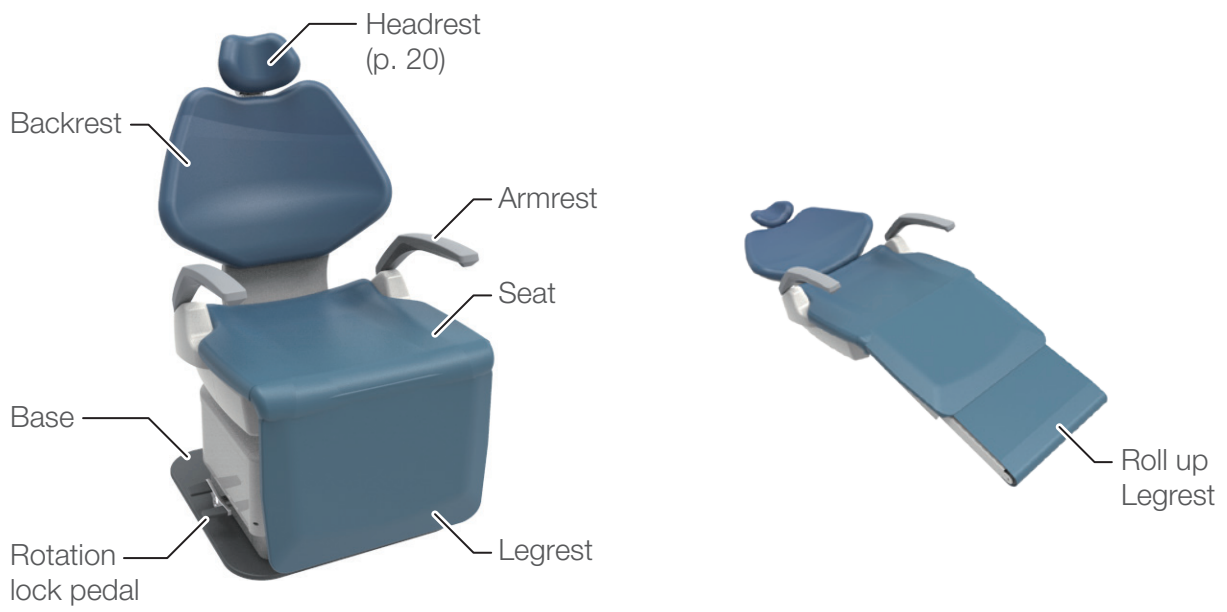

Inserting the power plug into the socket

Correctly insert the power plug into the socket with a ground terminal.

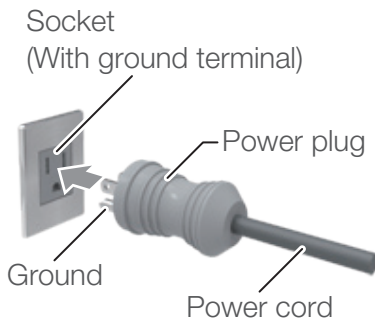

WARNING

Use an unshared socket with an attached ground terminal.

Be sure to fully insert the power plug into the socket until reaching the base of the plug.

Wipe off the dirt on power plug and socket with a dry cloth to avoid any possible fire.

Do not pull the cord to remove the power plug from the socket. Hold by the power plug at the end of the cord when removing.

Be careful when handling the power cord.

- Do not damage the cord.
- Do not place objects on top of the cord.
- Do not alter the cord.
- Do not heat the cord.
- Do not excessively bend, twist, or pull the cord.

Be careful of power cord or plug breakage.

Do not use any power cord or plug that is damaged, or that fits loosely when inserted into a socket.

Do not touch a power plug or socket with a wet hand.

Do not connect the earth (ground) to the following objects.

Water or gas pipes, lightning rods and telephone dedicated grounding wire

Consult an electrician for grounding procedures to ensure secure ground connections.

Turn off the power switch and remove the power plug from the socket when the chair is not in use.

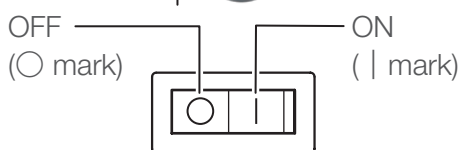

CAUTION

Turning on the power

Press the side with the | mark to turn the power on and the side with the O mark to turn the power off. A lamp in the power switch will illuminate.

Operate the power switch by hand only.

Rotating the Chair

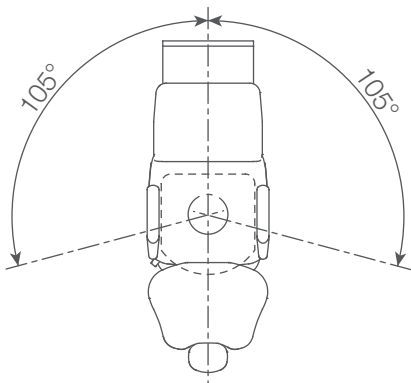
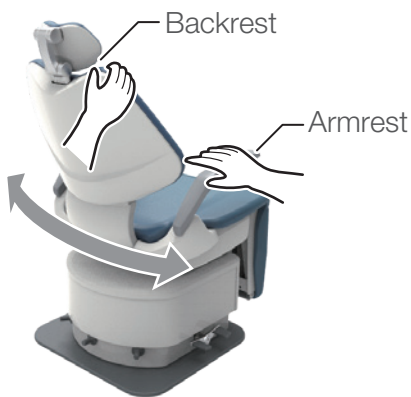
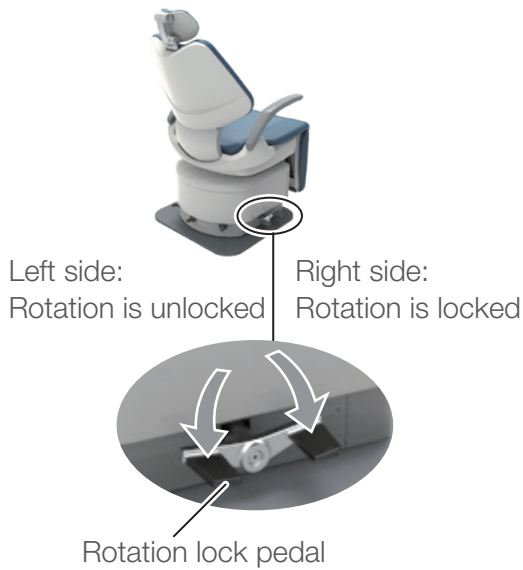

WARNING

By stepping on the right side of the rotation lock pedal, you can rotate the chair freely.

By stepping on the left side of the rotation lock pedal, you can lock the rotation of the chair at that position.

Hold the backrest or armrests when rotating the chair.

Rotation range: 210° (With the base facing forward, 105° to the right and 105° to the left)

When the patient sits on or gets out of the seat, be sure to put the product in the entry/exit position (seat is lowered to the bottom, the backrest is raised, and the rotating mechanism is locked).

Be careful of the following when rotating the chair in order to ensure safety.

- Lower the chair to the lowest position.
- Check that the patient is seated in the proper posture and position.
- Be sure that there are no other persons or things in the surrounding area, and ensure that the legrest and other parts do not contact the patient or any nearby equipment.

Be sure to always lock (secure) chair rotation after rotating the chair.

Adjust the Position of the Headrest

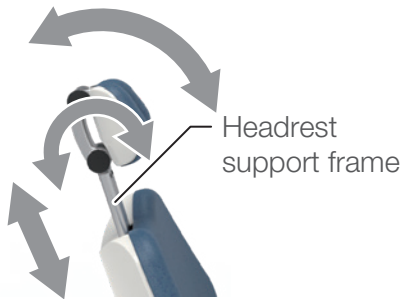
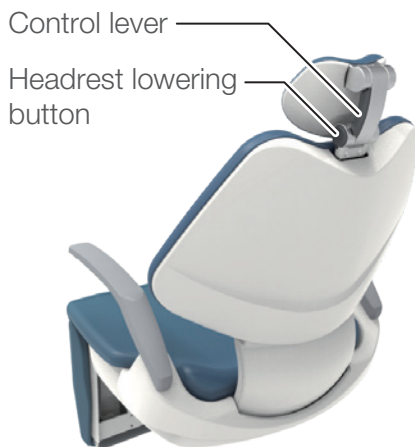

CAUTION

Angle adjustment of the headrest

Push the control lever to unlock and adjust headrest angle. Headrest angle is locked when the control lever is released.

Support the headrest from backward, then press the button to release the lock.

Up/down adjustment of the headrest

To raise the headrest, pull the headrest up slowly while holding it. To lower the headrest, apply the operator's hand to the headrest, and pull it down slowly while pressing the headrest lowering button.

Do not apply an excessive load or impact on the headrest. Doing so can result in damage.

Be careful not to get water or any chemical on the headrest support frame. Wipe off all water and chemicals immediately if any gets on these parts. Failure to do so can prevent the headrest from being securely fixed because of corrosion or degradation of friction force due to rust.

When operating the headrest, be careful not to get the operator's hand or finger caught around the control lever or between the headrest and the backrest.

Operation of Seat and Backrest (Manual Operation)



Stick Switch		State when moved
Operation direction	Label	
		Raise the seat
		Lower the seat
		Raise the backrest
		Recline the backrest

*The chair is operated while the stick switch is pushed down.

WARNING

Before raising/lowering the chair, confirm that no human body part, limb, or object is obstructing the chair.

Before reclining the backrest, confirm that the patient's arm or hand is not placed between the backrest and the seat.

Before raising the backrest, confirm that the patient's arm or hand is not placed between the backrest and the armrest.

Moving the Chair to Preset Positions (Automatic Operation)



Stick Switch for Auto Operation

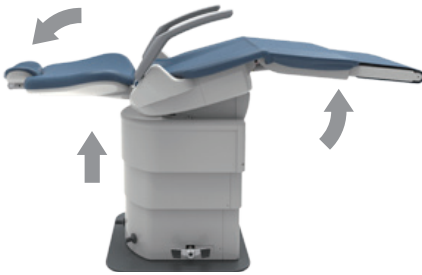

Move to treatment position.



Move to entry/exit position.

Stick Switch		State when moved
Operation direction	Label	
		The chair will move to desired treatment 1 position.
		The chair will move to desired treatment 2 position.
		The chair will move to desired treatment 3 position.
		The chair will move to desired entry/exit position.

Do not depress the auto operation stick switch for over 5 seconds, because the memorized position in auto mode may be changed. [Reference] Changing Treatment Position and Entry/Exit Position (p. 23)

WARNING

Before moving the chair, confirm that no human body part, limb, or object is obstructing the chair.

Moving the Chair to Preset Positions (Automatic Operation)

Canceling an Operation

During automatic movement (Preset, Automatic return and Last position memory), by pressing any side of the stick switches the automatic movement will be cancelled immediately. (An electronic beep is emitted when the operation is stopped (cancelled).)

Changing Treatment Position and Entry/Exit Position

You can alter the default of the Treatment Position and/or Entry/Exit Position by the following manner:

- 1 Set the seat and the backrest to the desired treatment position or entry/exit position by manual mode stick switch.
- 2 Press and hold the automatic mode stick switch to the desired position side until buzzer sounds (in about 5 seconds), then release it.

The position is memorized.

Set to treatment 1 position: Push down to left

Set to treatment 2 position: Push down to right

Set to treatment 3 position: Push down to up

Set to entry/exit position : Push down to down

- 3 After moving the chair position once, press the stick switch in the direction you have just set to confirm the newly memorized setup will function.

Positional Relation Between Backrest Position and Legrest Movement/Rollup Extension

Legrest raising angle and rollup extension are automatically controlled by backrest angle in automatic operation only.

You can't manually raise legrest nor use rollup extension.

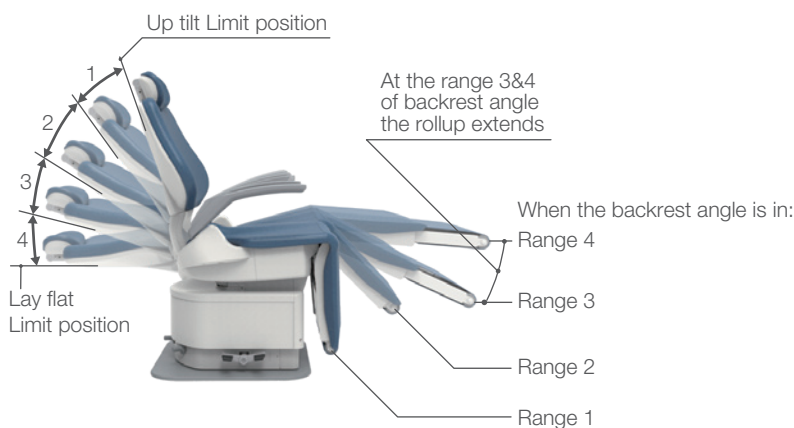

Operating the Legrest

"Legrest operation mode" controls the legrest operation.



1 Turn the stick switch for auto operation upward for 8 seconds or more.

The beeps sound after 5 seconds passed, and then the sound of beeps are changed after 3 seconds passed. After these procedures, the legrest operation mode is started.

Do not leave the stick switch for auto operation while the beeps are sounding. When leaving the stick switch, the position at the moment is memorized as the treatment 3 position.
 [Reference] Changing Treatment Position and Entry/Exit Position (p. 23)

2 Operate the legrest by the stick switch for manual operation.



Stick Switch		State when moved
Operation direction	Label	
		Raise the legrest
		Raise the legrest

*The product operates while the stick switch is kept pressed.

The extension range of the roll-up legrest is determined automatically by the angle of legrest.

3 To cancel the legrest operation mode, turn the stick switch for backrest operation to any directions for one second or more.

WARNING

Before raising/lowering the legrest, confirm that no human body part, limb, or object is obstructing the chair.

Armrest Rotation

If the armrest is in the way when sitting on or getting out of the chair or during treatment, you can rotate it to the rear.

Both armrests on the left and right can be rotated.

1 Pull the base of the armrest (on the rear side) in a diagonally upward direction.



2 Turn the armrest remaining in the place that has been pulled up to the outside of the chair.



3 To return the armrest to the normal position, turn it to the outside of the chair. When the armrest comes to a normal position, it will be locked.



CAUTION

When turning the armrest, confirm that there is no obstruction.

Operator must be careful not to get their hand or finger caught. Do not move the chair while the armrest has been turned backward. Return the armrest to the normal position before moving the chair.

Pinching Prevention

If a certain amount of force is applied in the direction of the arrow to the roll up legrest during operation, the pinching prevention function will operate, and the seat will rise for approx. 1 second and then stop.

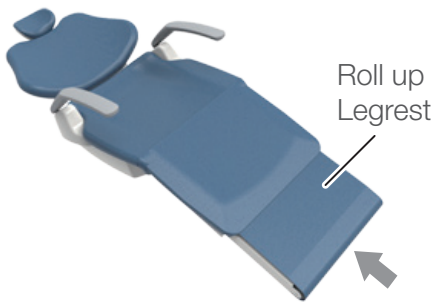

*While the legrest is rising by auto operation, the pinching prevention function will operate within the range of the legrest vertical to approx. 55°. Beyond this range, the pinching prevention function will not operate.

Remove the cause of the stoppage, confirm the safety, then restart operation.

Legrest is rising by auto operation



Lowering by manual / auto operation

Clean this chair after use to maintain it in a clean state.

WARNING

Turn off the power switch and unplug the power plug before cleaning. Failure to do so can result in electric shock or fire. Also, sudden movement of the chair while cleaning can result in injury.

Do not wash with water. This may cause failure or electric shock.

Poor cleaning may cause bacteria to grow, posing a health risk.

CAUTION

The metal and mechanical parts of the chair have sharp edges. Be careful when cleaning the chair that your hands, fingers or other body parts are not injured.

Leather Parts and Plastic Parts

Wipe gently off with a dry soft cloth.

If extremely dirty

Wipe off any stain by using a soft cloth that has been dabbed with a neutral detergent diluted with water to approximately 10%, wipe it with a damp cloth and thoroughly wipe it dry.

Parts touched by the patient

Use a soft cloth saturated with disinfectant to clean the cushion parts, such as the headrest, backrest, seat, legrest, and armrest, as well as the other parts possibly touched by the patient.

As an example of disinfectant solutions for cleaning, use FD366 manufactured by Dürr or OPTIM33TB manufactured by SciCan.

Control Panels and Metal Parts

Wipe clean using a dry soft cloth.

Do not clean these parts with a wet cloth because they are readily affected by moisture and water. Wipe off all moisture immediately if any water gets on these parts. Water left on these parts will result in rust or malfunction of electronic parts.

Do not use any of the following substances to clean the chair. Thinner, nail polish remover, volatile chemicals (such as gasoline or kerosene), acid or alkaline solutions, chlorinated cleaners, disinfectants that are highly corrosive to metal, povidone iodine (iodine solution), sodium hypochlorite, waxes containing abrasive compounds, sponges containing abrasive compounds and similar substances.

Do not use brushes, scouring brushes or similar items when cleaning the chair. Using them will damage the chair or result in the inability to clean off the dirt or grime.

Do not clean leather parts using a cleaner or bleach containing organic solvent or abrasive compounds. Such substances can cause the leather surface to deteriorate or dull the luster.

Clean a chair that has not been used for an extended period before using again. After cleaning, be sure to always check that the chair operates properly.

If you encounter any of the problems listed below, take the countermeasures described below before requesting a repair. If the problem persists even after troubleshooting, stop using the product immediately, turn off the power switch, and contact your local authorized Belmont dealer.

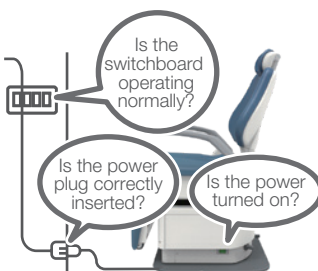
Problem	Check Points	Recovery Procedures
<p>The product does not work at all.</p> 	Is the power plug fully inserted to the base of the plug?	Fully insert the power plug into the socket until reaching the base of the plug. (p. 18)
	Is power switch on?	Turn on the power switch. (p. 18)
	Has a fuse or a breaker on the clinic's switch board blown?	Replace the fuse or turn on the breaker.
	Has the chair been operated for an extended period continuously?	<p>The problem is due to the operation of the overheating prevention device. ⇒Leave the chair for approximately 10 min. to allow it to return to the normal condition.</p> <p>Overheating Prevention Device This is a protective circuit that prevents abnormal overheating of internal mechanisms due to continuous operation and similar causes. The chair might stop operating temporarily.</p>
The chair unexpectedly stops.	Is there an object interfering with the roll up legrest and applying a force to it?	The problem is due to the operation of the pinching prevention function. Remove the cause of the stoppage and operate the chair. (p. 26)

These are not malfunctions	
Sound at startup	Such sound is due to the internal hydraulic fluid being cold. It is not a functional fault and should stop shortly thereafter.
Slow movement of the chair	Such movement is due to the internal operating fluid being cold. Raise the room temperature or continue operating for a short period. It will recover to the normal condition.
Sound when rotating the chair	This is the sound of the steel balls rolling when the chair is rotated. The level of this sound varies depending on the environment where the chair is installed.

Guide for daily maintenance and inspection (Maintenance and inspection by user)

Management of maintenance and inspection of medical equipment should be implemented by the user (medical institution). For safe use of the product, it is necessary that inspection should be conducted in the specified frequency on the items described below. If the chair does not work normally, immediately stop using the chair, turn off the power, unplug the power plug, and contact your local authorized Belmont dealer.

No.	Item	Frequency	Inspection method and diagnosis	Influence if inspection not conducted	Maintenance required in case of nonconformity
1	Confirmation of the cancel function for auto operation	Before start	Operation should stop if any of the stick switches is pushed during auto operation.	Unexpected personal injury and troubles may arise due to motion of the chair during medical treatment and due to pinching between doctor section and chair.	Contact your local authorized Belmont dealer if any abnormality arises.
2	Power supply cable	Before start	Power supply cable should not be abnormally bent, pinched or damaged, and the plug should be firmly inserted to the power socket and not covered with dust.	Accident or defect of the equipment.	Clean and rearrange the cable. For replacement, contact your local authorized Belmont dealer.
3	Function of each switch	Before start	Each switch for chair operation should work correctly.	Defect of movement may cause an accident.	Contact your local authorized Belmont dealer if any abnormality arises.
4	Moving parts	Before start	Make sure that the chair does not make any abnormal noise during automatic and manual movement.	Accident or defect of the equipment.	Contact your local authorized Belmont dealer if any abnormality arises.
5	Oil leakage	Before start	Make sure that there is no hydraulic oil on the floor or chair base leaking from the cylinder.	Defect of the equipment.	Contact your local authorized Belmont dealer if any abnormality arises.
6	Stain removal of external parts	After closing	Visual check the attachment of dust, chemicals or drug and grasp the total product condition.	Discoloration, transformation or breakage of resin parts may arise.	Clean up according to the "Cleaning Procedures" in this instructions for use.

WARNING

Always refer to this Guide before conducting daily maintenance and inspection.

If you do not conduct daily maintenance or inspection, use of the product may result in injury or damage to nearby devices.

Notes for periodic inspection

The product contains parts that stop functioning or wear depending on the use frequency, and therefore it is important to carry out maintenance in a periodic inspection once a year (including replacement of consumables) and safety checks.

Service parts required for the periodic inspection (including consumables) are listed in the table below. However, depending on the specifications of your device, there may be alternative parts available that differ from those listed in the table below.

Maintenance and inspection can be outsourced to qualified persons such as authorized repairers of medical devices. If you have any question about periodic inspection, contact your local authorized Belmont dealer.

List of service parts required for the periodic inspection

Parts Description	Standard Lifetime	Parts Description	Standard Lifetime
Headrest moving parts	2 years	Armrest moving parts	5 years
Electric wiring of moving parts	5 years	Hydraulic moving part	5 years
Switches	5 years	(O-ring, Packing)	
Backrest moving parts	5 years	Solenoid Valve	7 years
Legrest moving parts	5 years		

WARNING

Always entrust periodic inspection to your local authorized Belmont dealer. If you do not carry out periodic inspection, use of the product may cause injury or damage to nearby devices.

Environmental Conditions for Transportation or Packaging

- (1) Environmental conditions for the transportation or packaging for Estorage of the product shall be as specified below.

Temperature -20 ~ 70°C

Humidity 10 ~ 95%

Air pressure 700 ~ 1060 hPa

- (2) Pay attention to the following items for the storage area.

Store the equipment in places with water not sprayed on it.

Store the equipment in places where it has no adverse influences of atmospheric pressure, temperature, humidity, ventilation, sunlight, dust, and air containing salt or sulfur.

Pay careful attention to keep the equipment in a steady state, avoiding inclination, vibration, and shock (including those during transport).

Do not store the equipment in places where chemicals are stored or gases are generated.

Storing Method

In case of not using the product for a long period, store it in the following conditions.

1. Set the chair at the minimum height position.
2. Make sure to disconnect the power supply plug from the socket.

Service Life

The durable period of the product is 10 years (self-certification based on in-house data) from manufacturing and shipment, provided regular maintenance and inspection is done. However, parts requiring periodical maintenance have different durability periods. (p. 30)

Consumable Parts

The consumable parts are predicted to be abrasion, deterioration, and changes in external appearance or damage through use. Please note that repair or replacement of these parts is not covered by warranty, and fees will be required.

(The level and period of abrasion, deterioration or damage may differ depending on the environment and condition that the client uses the product in)

Consumable parts (The following parts are not covered by the warranty and must be purchased.)

O-ring, Packing

Also, the exterior parts (leather parts, metal parts, plastic parts, etc.) are not covered by the warranty in cases of exterior damage, dirt, deterioration, color fading, or similar problems.

This product is compliant with EMC standard IEC 60601-1-2:2007.

1. **Observance of precautions regarding EMC and affiliated documents**
Medical electrical equipment needs special precautions regarding EMC and needs to be installed and put into service according to the EMC information provided in this manual.
2. **Influence of RF communications equipment**
Portable and mobile RF communications equipment can affect medical electrical equipment.
3. **Warning prohibiting proximity and stacking with other equipment**
The equipment or system should not be used adjacent to other equipment. If adjacent or stacked use is necessary, the equipment or system should be observed to verify normal operation in the configuration in which it will be used.
4. **Declaration of electromagnetic emission**

Guidance and manufacture's declaration - electromagnetic emissions		
The PROIII 047 is intended for use in the electromagnetic environment specified below. The customer or the user of the PROIII 047 should assure that it is used in such an environment.		
Emissions test	Compliance	Electromagnetic environment - guidance
RF emissions CISPR 11	Group 1	The PROIII 047 uses RF energy only for its internal function. Therefore, its RF emissions are very low and are not likely to cause any interference in nearby electronic equipment.
RF emissions CISPR 11	Class B	The PROIII 047 is suitable for use in all establishments, including domestic establishments and those directly connected to the public low-voltage power supply network that supplies buildings used for domestic purposes.
Harmonic emissions IEC 61000-3-2	Not applicable	
Voltage fluctuations/ Flicker emissions IEC 61000-3-3	Not applicable	

5. Declaration of electromagnetic immunity 1

Guidance and manufacture's declaration - electromagnetic immunity			
The PROIII 047 is intended for use in the electromagnetic environment specified below. The customer or the user of the PROIII 047 should assure that it is used in such an environment.			
Immunity test	IEC 60601 test level	Compliance level	Electromagnetic environment - guidance
Electrostatic discharge (ESD) IEC 61000-4-2	±6 kV contact ±8 kV air	±6 kV contact ±8 kV air	Floors should be wood, concrete or ceramic tile. If floors are covered with synthetic material, the relative humidity should be at least 30%.
Electrical fast transient/burst IEC 61000-4-4	±2 kV for power supply lines ±1 kV for input/output lines	±2 kV for power supply lines ±1 kV for input/output lines	Mains power quality should be that of a typical commercial or hospital environment.
Surge IEC 61000-4-5	±1 kV differential mode ±2 kV common mode	±1 kV differential mode ±2 kV common mode	Mains power quality should be that of a typical commercial or hospital environment.
Voltage dips, short interruptions and voltage variations on power supply input lines IEC 61000-4-11	<5% U_T (>95% dip in U_T) for 0.5 cycle 40% U_T (60% dip in U_T) for 5 cycle 70% U_T (30% dip in U_T) for 25cycle <5% U_T (>95% dip in U_T) for 5 s	<5% U_T (>95% dip in U_T) for 0.5 cycle 40% U_T (60% dip in U_T) for 5 cycle 70% U_T (30% dip in U_T) for 25cycle <5% U_T (>95% dip in U_T) for 5 s	Mains power quality should be that of a typical commercial or hospital environment. If the user of the PROIII 047 requires continued operation during power mains interruptions, it is recommended that the PROIII 047 be powered from an uninterruptible power supply or a battery.
Power frequency (50/60 Hz) magnetic field IEC 61000-4-8	3 A/m	3 A/m	Power frequency magnetic fields should be at levels characteristic of a typical location in a typical commercial or hospital environment.
NOTE U_T is the a.c. mains voltage prior to applications of the test level.			

6. Declaration of electromagnetic immunity 2

Guidance and manufacture's declaration - electromagnetic immunity			
The PROIII 047 is intended for use in the electromagnetic environment specified below. The customer or the user of the PROIII 047 should assure that it is used in such an environment.			
Immunity test	IEC 60601 test level	Compliance level	Electromagnetic environment - guidance
Conducted RF IEC 61000-4-6	3 Vrms 150 kHz to 80 MHz outside ISM bands ^a	3 Vrms	Portable and mobile RF communications equipment should be used no closer to any part of the PROIII 047, including cables, than the recommended separation distance calculated from the equation applications to the Frequency of the transmitter. Recommended separation distance $d = 1.2\sqrt{P}$
Radiated RF IEC 61000-4-3	3V/m 80 MHz to 2.5 GHz	3 V/m	$d = 1.2\sqrt{P}$ 80 MHz to 800 MHz $d = 2.3\sqrt{P}$ 800 MHz to 2.5 GHz Where P is the maximum output power rating of the transmitter in watts (W) according to the transmitter manufacturer and d is the recommended separation distance in metres (m). Field strengths from fixed RF transmitters, as determined by an electromagnetic site survey, ^a should be less than the compliance level in each frequency range. ^b Interference may occur in the vicinity of equipment marked with the following symbol: 
<p>NOTE 1 At 80 MHz and 800MHz, the higher frequency range applies.</p> <p>NOTE 2 These guidelines may not apply in all situations. Electromagnetic propagation is affected by adsorption and reflection from structures, objects and people.</p> <p>a Field strengths from fixed transmitters, such as base stations for radio (cellular/cordless) telephones and land Fmobile radios, amateur radio, AM and FM radio broadcast and TV broadcast cannot be predicted theoretically with accuracy. To assess the electromagnetic environment due to fixed RF transmitters, an electromagnetic site survey should be considered. If the measured field strength in the location in which the PROIII 047 is used exceeds the applicable RF compliance level above, the PROIII 047 should be observed to verify normal operation. If abnormal performance is observed, additional measures may be necessary, such as reorienting or relocating the PROIII 047.</p> <p>b Over the frequency range 150 kHz to 80 MHz, field strengths should be less than 3V/m.</p>			

7. Recommended separation distances

Recommended separation distances between Portable and mobile RF communications equipment and the PROIII 047.			
The PROIII 047 is intended for use in an electromagnetic environment in which radiated RF disturbances are controlled. The customer or the user of the PROIII 047 can help prevent electromagnetic interference by maintaining a minimum distance between portable and mobile RF communications equipment (transmitters) and the PROIII 047 as recommended below, according to the maximum output power of the communications equipment.			
Rated maximum output power of transmitter W	Separation distance according to frequency of transmitter m		
	150 kHz to 80 MHz $d = 1.2\sqrt{P}$	80 MHz to 800 MHz $d = 1.2\sqrt{P}$	800 MHz to 2.5 GHz $d = 2.3\sqrt{P}$
0.01	0.12	0.12	0.23
0.1	0.38	0.38	0.73
1	1.2	1.2	2.3
10	3.8	3.8	7.3
100	12	12	23
For transmitters rated at a maximum output power not listed above, the recommended separation distance d in metres(m) can be estimated using the equation applicable to the frequency of the transmitter, where P is the maximum output power rating of the transmitter in watts (W) according to the transmitter manufacturer. NOTE 1 At 80 MHz and 800MHz, the separation distance for the higher frequency range applies. NOTE 2 These guidelines may not apply in all situations. Electromagnetic propagation is affected by adsorption and reflection from structures, objects and people.			

8. Essential performance

Unless operated by the switches for chair control, the PROIII 047 does not make any movements, except for sounding a buzzer and switching on/off the indicator.

Specifications

Model No.	AC-47R-FD36
Type of protection against electric shock Class I equipment
Degree of protection against electric shock B-type isolated applied parts (leather-covered parts)
Rated Power Supply AC120V 60Hz 3.8A
Fuse P.C.B. for Chair control 1.25A/250V (Breaking Capacity : 1500A/250VAC)
Mode of Operation Non-Continuous Operation (Motor) Duration of Maximum Operating Time:3min Duty 1:15
Net Weight 167kg
Seat Initial Height/ 480/245mm
Seat Lifting Stroke	
Lifting mechanism Electric-hydraulic Motor
Maximum lifting capability 135kg
Headrest Manual
Backrest Electric-hydraulic Motor
Seat With Backrest Synchronized Tilting Mechanism
Legrest Electric-hydraulic Motor
Roll up Legrest Electric-hydraulic Motor
Armrest With rotation function on both sides
Upholstered section Synthetic Leather
Operation switch Stick Switch
Use environment Temperature 0 ~ 40°C Humidity 10 ~ 95% Air pressure 700 ~ 1060 hPa

Unit: inch (Dimensional tolerance:±10%)
* Dimensions and specifications are subject to change without notice.

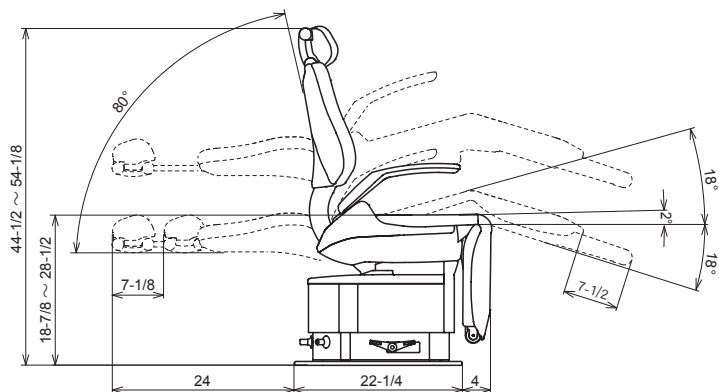
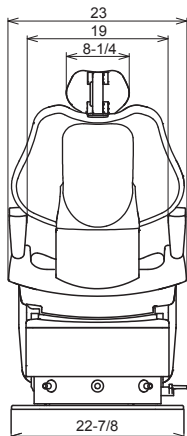
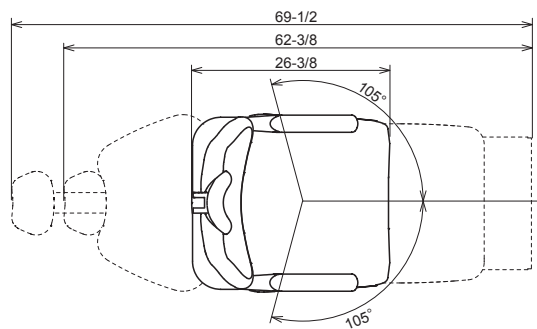



Importer for U.S.A.

BELMONT EQUIPMENT,

Division of Takara Belmont USA, Inc

101 Belmont Drive, Somerset, New Jersey 08873 U.S.A.

TEL : (732) 469-5000 / (800) 223-1192

FAX : (732) 526-6322 / (800) 280-7504

Importer for Canada

TAKARA COMPANY, CANADA, LTD.

2455 Meadowvale Blvd. Mississauga, Ontario L5N 5S2, Canada

TEL : (905) 816-8965

www.belmont.ca

TAKARA BELMONT CORPORATION

2-1-1, Higashishinsaibashi, Chuo-ku, Osaka, 542-0083, Japan

TEL : +81-6-6213-5945

FAX : +81-6-6212-3680

