



# Bel Series

## Dental Light

---

Designed to empower  
exceptional care.



**Bel Halo**  
Dental Light

**Bel Nova**  
Dental Light

Scan for other brochures





# Be

## **Bel Halo** Dental Light

---

### **Shining a Light on Excellence**

Illuminate your workspace with the Bel-Halo Dental Light, crafted to deliver precision and comfort throughout procedures. Its novel halo design delivers superior illumination, ensuring enhanced visibility for intricate treatments. Adjustable intensity settings and a sleek, ergonomic design minimizes eye strain and maximizes focus. Let the Bel-Halo Dental Light illuminate your path to exceptional dental care, shining a light on excellence with every procedure.



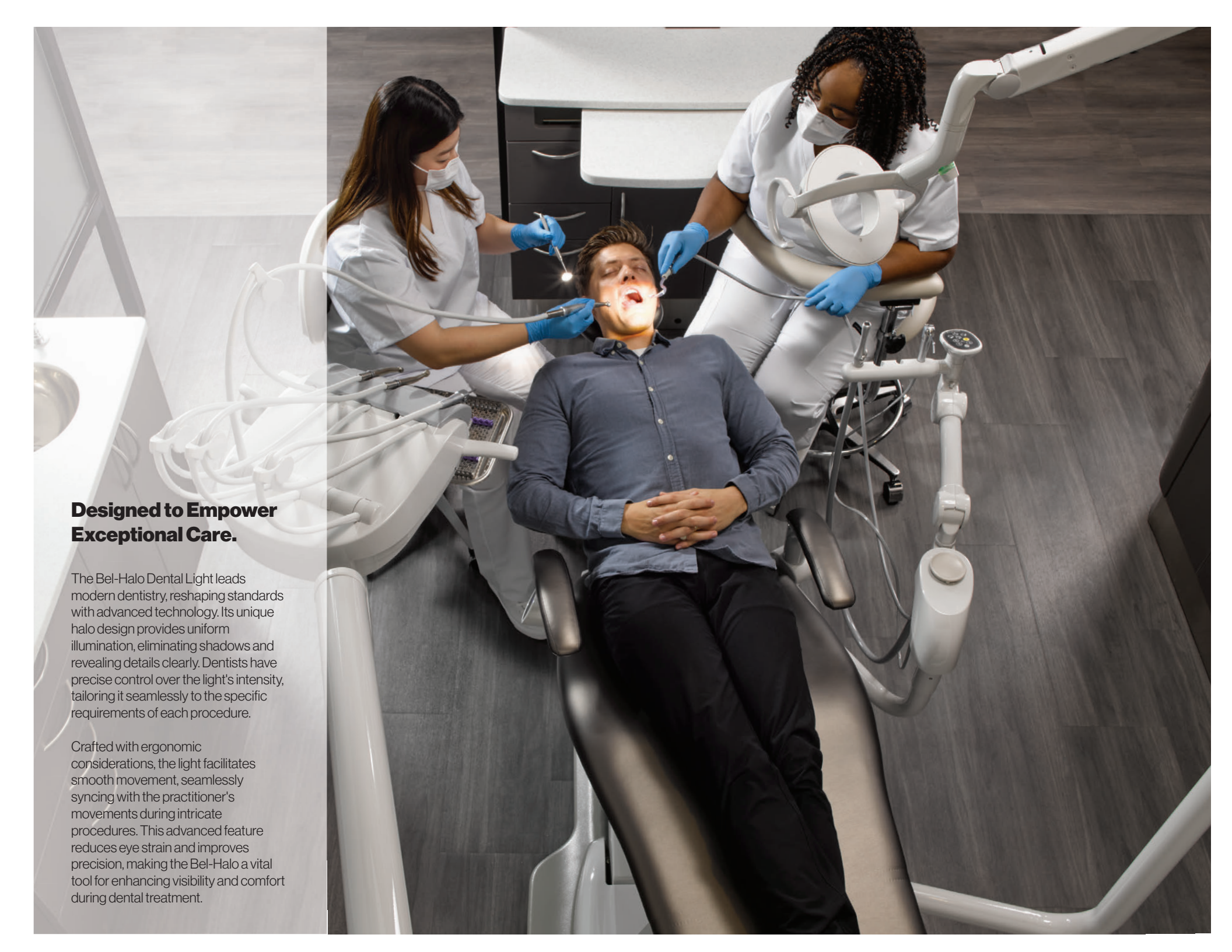

## Designed to Empower Exceptional Care.

The Bel-Halo Dental Light leads modern dentistry, reshaping standards with advanced technology. Its unique halo design provides uniform illumination, eliminating shadows and revealing details clearly. Dentists have precise control over the light's intensity, tailoring it seamlessly to the specific requirements of each procedure.

Crafted with ergonomic considerations, the light facilitates smooth movement, seamlessly syncing with the practitioner's movements during intricate procedures. This advanced feature reduces eye strain and improves precision, making the Bel-Halo a vital tool for enhancing visibility and comfort during dental treatment.

## Shadow-free Illumination.

Powered by top-tier LED technology, the Bel-Halo Dental Light delivers shadow-free illumination, guaranteeing precise and uniform lighting throughout the treatment zone. Its shadowless illumination technology allows for uninterrupted lighting to the patient oral cavity, even with a 50% obstruction between the light and patient head.

## Treatment and Composite Safe Modes

The Bel-Halo's Dental Light's composite safe mode prevents premature curing of composite materials, giving dentists more time for precise manipulation before setting. This empowers dentists to deliver superior quality dental care, minimizing procedural risks, maximizing efficiency, and ultimately leading to more successful treatment outcomes.





## Mounting Option

The Bel-Halo Dental Light offers five mounting options: track, ceiling, post, wall, and cabinet, for versatile installation in any dental office. Whether you seek to equip a space with tall 8-to-foot ceilings or need to maximize your space, Belmont offers a wide range of mounting options to bring to the Bel-Halo to your operator.

■ Unit Mount



■ Post Mount



■ Ceiling Mount



■ Track Mount



■ Cabinet Mount



■ Wall Mount



## Dimensions

■ Unit Mount

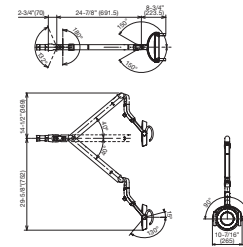

■ Post Mount

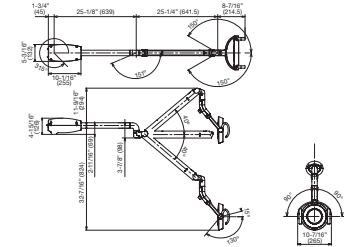

■ Ceiling Mount

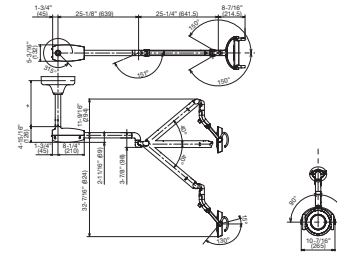

\*Select suspension tube length based upon ceiling height.

■ Track Mount

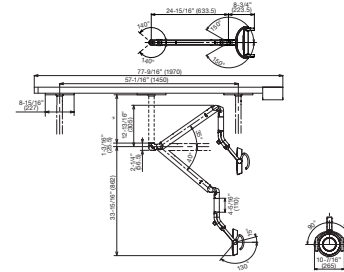

\*Select suspension tube length based upon ceiling height.

■ Cabinet Mount

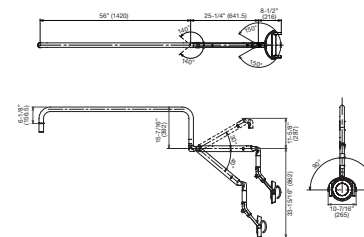

Unit: inch (mm)  
Tolerance in dimensions: ±10%

■ Wall Mount

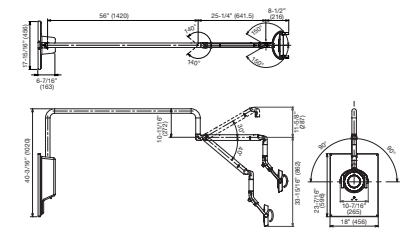

# Be

## **Bel Nova** Dental Light

---

### **Innovation meets illumination.**

Illuminate your dental practice with the Bel-Nova dental light, engineered to provide unparalleled precision and comfort during procedures. This innovative light features powerful array of six LED lights to ensure optimal illumination and clear visibility. Say goodbye to shadows and eye strain, as the Bel-Nova's forward-thinking design delivers precise lighting without compromising on comfort.

See your practice in a new light with the Bel-Nova dental light, where brightness, efficiency, and quality shine.

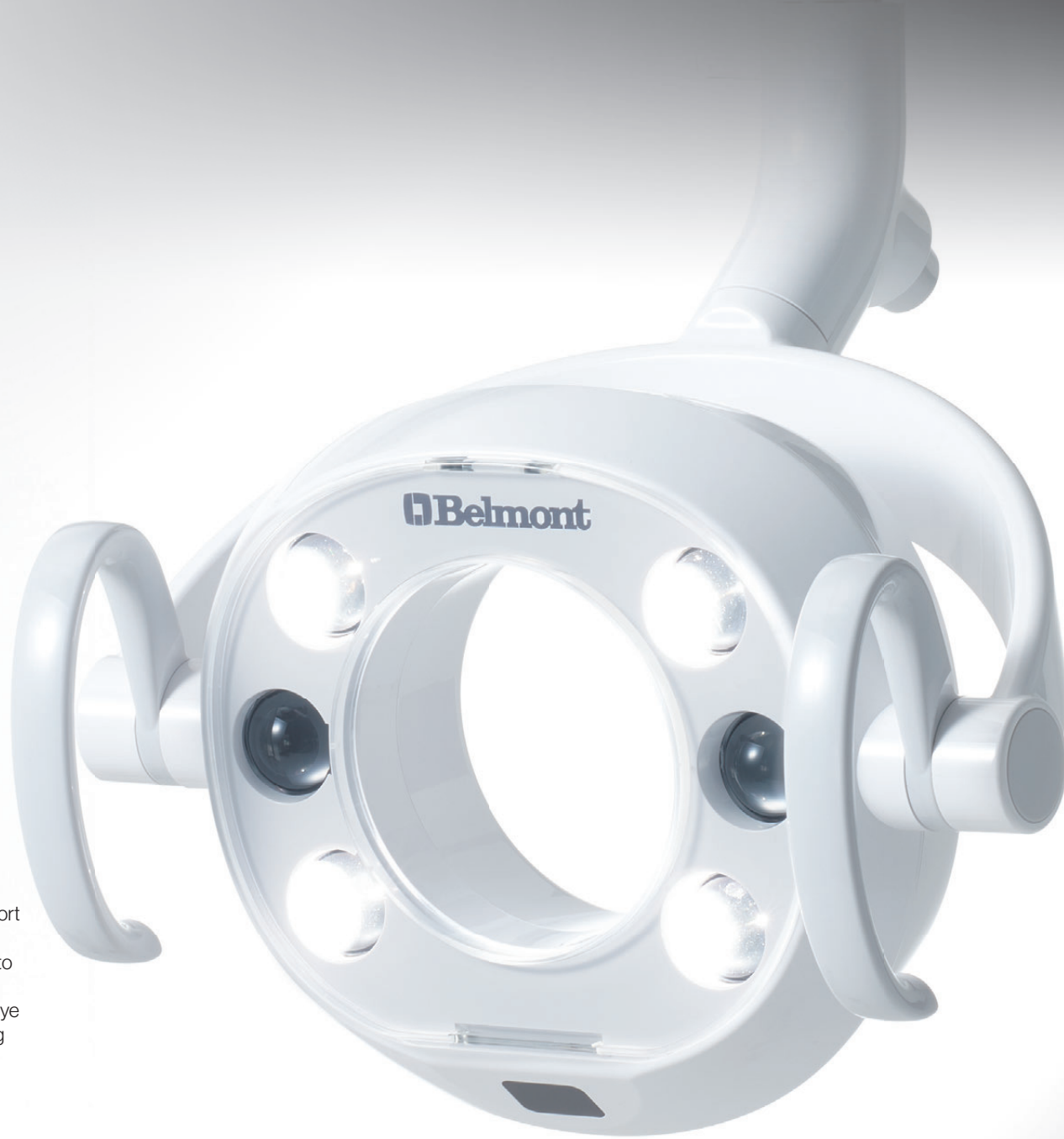

## Out of shadows The Belmont standard

Belmont's Bel-Nova boasts an advanced six-LED array, optimizing patient treatment and composite work. Its oval lighting pattern ensures precise illumination without eye discomfort, emitting less heat than traditional bulbs.



Enhance patient safety and confidence while maintaining a clean treatment environment with the Bel-Nova. From touchless sensor-activation to hygiene covers, this advanced light is designed to minimize surface contamination and promote optimal hygiene standards in your practice.



## Lighting the way

Illuminate your dental practice with the Bel-Nova dental light, offering advanced six-LED array technology for optimized patient treatment and composite work. Its oval lighting pattern ensures precise illumination of the patient's mouth, minimizing discomfort and maximizing visibility during procedures.

With touchless sensor-activated switches and stepless technology, the Bel-Nova provides unparalleled control over surface contamination and luminosity preferences, enhancing both hygiene and efficiency in your practice.

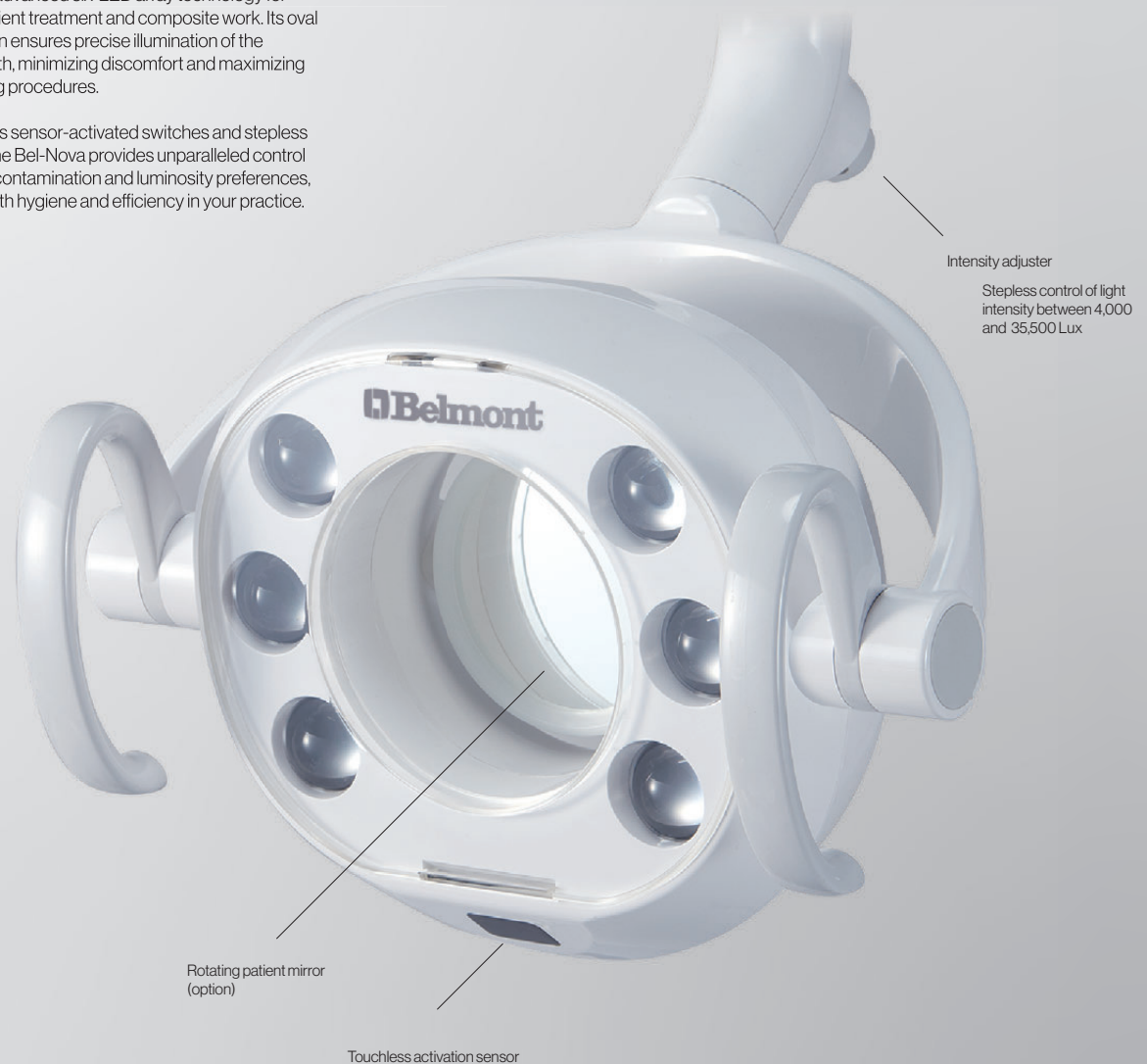

## Mount Option



Stand-Alone Left-Right Swing



Ceiling Mounted



Track Mounted



Post Mounted



Cabinet Mounted



Wall Mounted

## Dimensions

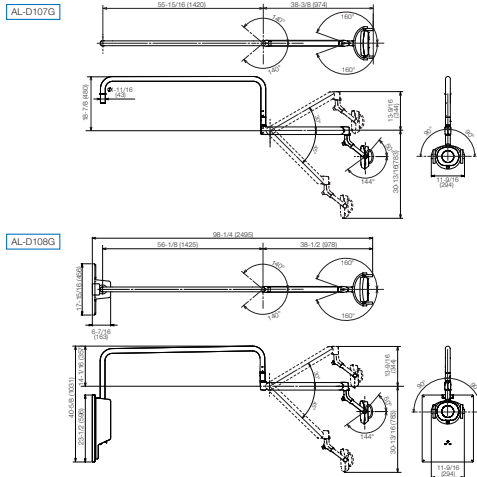

Discover versatility with the Bel-Nova Dental Light, available in five mounting styles: ceiling, track, post, cabinet, and wall. Crafted for seamless integration, each option offers tailored solutions for your practice layout.





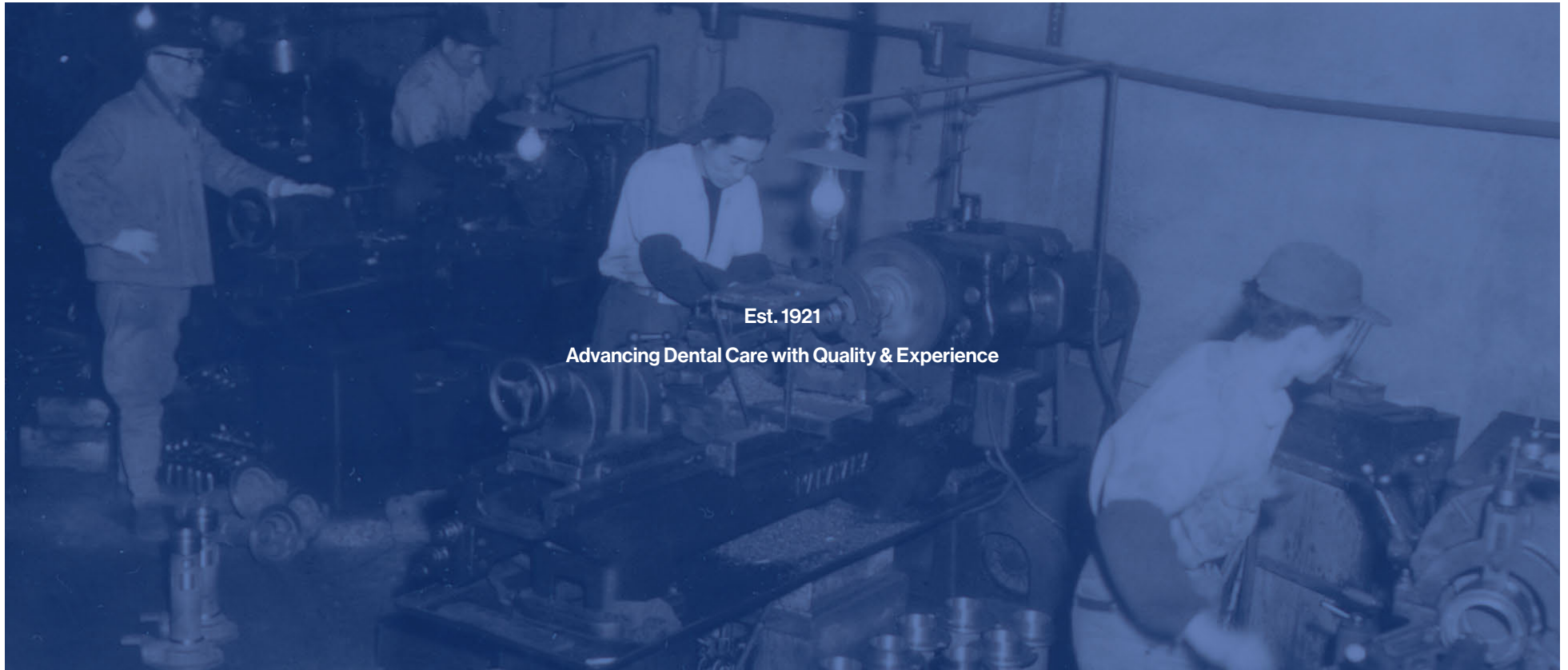

Est. 1921

Advancing Dental Care with Quality & Experience

 **Belmont**

Belmont Equipment  
Takara Company Canada Ltd.

101 Belmont Drive, Somerset, NJ 08873  
2455 Meadowvale Boulevard, Mississauga, Ontario, L5N 5S2

(800) 223-1192 [www.belmontequip.com](http://www.belmontequip.com)

(800) 268-5351 [www.belmont.ca](http://www.belmont.ca)

The specifications and colors are subject to change without notice.