



Evogue Series

Delivery Systems

Designed to empower
exceptional care.



Evogue Flex
Delivery System

Evogue Traditional
Delivery System

Evogue Mobile Cart
Delivery System

Scan for other brochures



Be

Evogue Flex

Delivery Systems

Uncover unrivaled efficiency with the EVOGUE Flex delivery system—a meticulously crafted solution for an successful dental practices. This industry-leading system boasts intuitive controls and customizable configurations, ensuring every tool is easily accessible. With its ergonomic design and adaptable arm, the delivery system seamlessly adjusts to any treatment scenario, optimizing workflow efficiency and enhancing patient comfort. Embrace the precision and versatility of the Evogue Flex Delivery System to elevate your practice and embrace the future of dental care.





Feel like zero gravity,
lower fatigue,
higher performance.

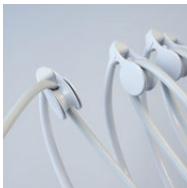

EVOGUE Flex

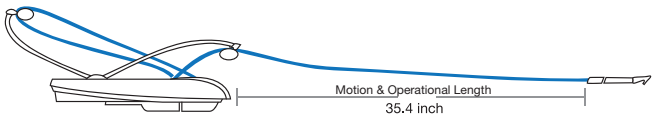

Competitor

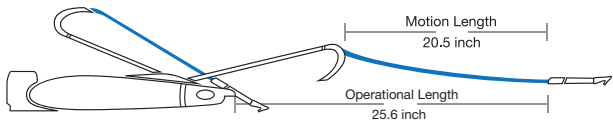

Discover a new realm of accessibility with the Evogue Flex Delivery System, setting a new standard in dental care. Its cutting-edge design extends the reach of dental tools, ensuring effortless access and maximizing efficiency and comfort during every procedure. With its innovative features and superior performance, the Evogue Flex surpasses competitors, establishing itself as an indispensable asset for any modern dental practice.

Experience the comfort and ease of operation with the EVOGUE Flex's innovative system that makes dental instruments feel like there is zero gravity. Precisely-engineered to diminish fatigue and amplify accuracy, this delivery system facilitates fluid, seamless movement throughout treatments. Its ergonomic design promotes natural motions, reducing strain and optimizing control. Upgrade to the Evogue Flex Delivery System to transform your practice with seamlessly integrated technology, empowering you to excel in your professional endeavors.



Effortless Adjustments, Unimpeded Movement.

Effortlessly adjust the system's rotating delivery head to place the table in familiar, patient-friendly positions—pivot the tray or table to maximize your access. This valuable feature eliminates tubing pullback, ensuring smooth and unimpeded movement. For maximum support, the tray can be adjusted into various positions enhancing both comfort and efficiency.

Explore the freedom and precision of the Evogue Flex, expertly crafted to achieve unparalleled.



Different mounting options

PMU mount

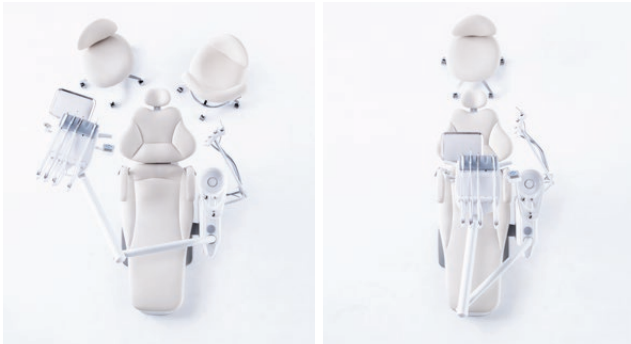

Traditional style positioning/ 4 hands

European style positioning/ 2 hands

Swing mount



Right handed/ 2 hands

Left handed/ 4 hands

The Evogue Flex Delivery System is a strategic investment for any dental practice. Offering two versatile mounting options, it seamlessly adjusts to different treatment room setups, ensuring smooth integration and optimal functionality in diverse environments. Beyond improving efficiency and aesthetics, it delivers consistent performance and unwavering support in every setting. Unlock your practice's full potential with the Evogue Flex, a system that adapts to your needs, propelling your dental practice towards greater success.



Traditional style positioning/ 4 hands



Traditional style positioning/ 4 hands

Adaptive Mounting Solutions, Versatile Operating Capabilities.

The left-right swing mount feature of the Evogue Flex is ideal for dental practices that have multiple providers. This innovative feature enables effortless adjustment between left and right-handed operations, ensuring comfort and efficiency for all dentists, regardless of their dominant hand. By accommodating diverse working styles, the Evogue Flex streamlines workflow and minimizes setup time, a significant advantage for bustling, multi-provider clinics.

The adaptable left-right swing mount of the Evogue Flex is tailored to meet the unique requirements of each provider in a shared workspace, fostering an ergonomic and comfortable work setting while optimizing the utilization of treatment areas. Providers can seamlessly personalize the setup to suit their preferred orientation, ensuring optimal access and control during procedures, ultimately enhancing the standard of patient care.

Durability Test 500,000+.

10 times per treatment
x10 times per day
x250 days per year
x20 years

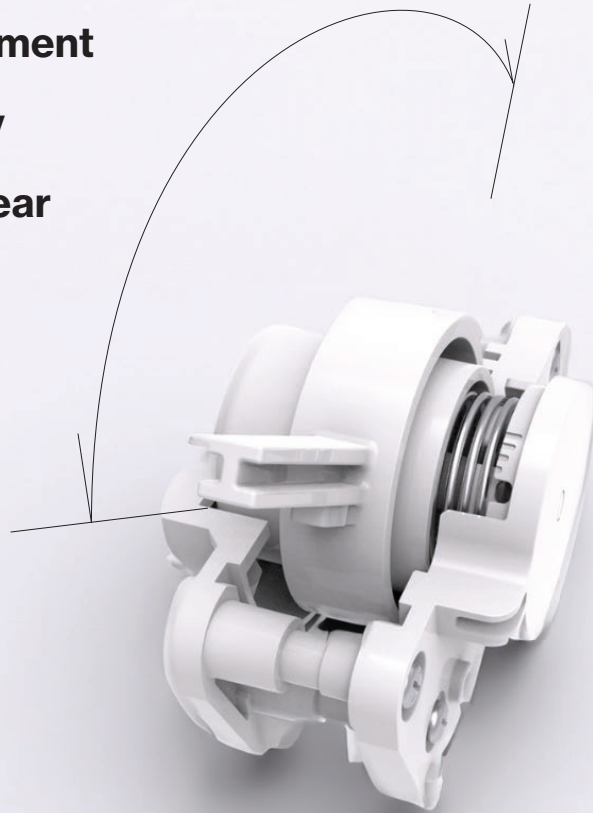

Quality Assured.

The Evogue Flex Delivery System epitomizes quality and reliability, consistently surpassing expectations with its exceptional performance.

We pride ourselves on our extensive evaluation process, which includes rigorous durability tests, operational simulations, and performance assessments, all aimed at upholding the highest standards of excellence.

With a steadfast focus on longevity and dependability, the Evogue Flex offers a reliable solution for all your dental care needs.





Specification

Assistant's Instruments

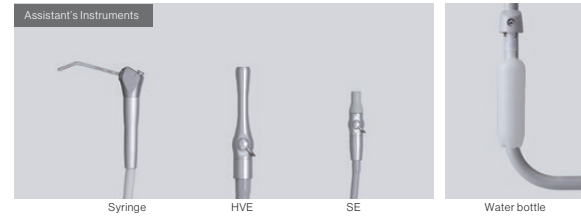

Syringe

HVE

SE

Water bottle

Integrated options



Bien Air MX2 PLUS

Cavitron

Acteon SP Newtron
piezo scaler with LED

Acteon SP Newtron
piezo scaler without LED

Delivery Systems	Flex Continental style
Convenient chair control touch pad	●
Tray holder (size: 290 x 190 mm)	●
Handpiece holder positions	3+Syringe
Handpiece instruments	●
- 3x Midwest 4 holes turbine hose	(standard spec)
- 1x Air/Water syringe	○
Midwest 4-hole turbine hose with fiber optic	○
Bien Air micromotor system	○
Cavitron magnetostriuctive scaler	○
Acteon SP Newtron piezo scaler with LED	○
Acteon SP Newtron piezo scaler without LED	○
Left/right conversion (swing mount delivery only)	●
Balance arm with air brake	●
2 Brake handles	●
Flushing system	●
Water system (2L bottle)	●
Junction box	●
Wet/Dry Foot Control	●

Assistant's Systems	
Left/right conversion (swing mount delivery only)	●
Breakaway assistant arm	●
Handpiece instruments	●
- 1x high volume evacuation (HVE)	●
- 1x saliva ejector (SE)	●
- 1x Air/Water syringe	○
- 1x option (2nd HVE)	○
Rotating cuspidor bowl_porcelain (OTP delivery only)	○
1/4 Water Quick Disconnect with outlet flow control	●
1/4 Air Quick Disconnect	●

Accessories	
Monitor swing arm and mount (swing mount delivery only)	○

● standard ○ option



Be

Evogue Traditional Delivery Systems

Dynamic solutions for your evolving dental practice.

Elevate treatment productivity with the EVOGUE dental delivery system. Smartly designed for easy controls and versatile motion, it adapts to evolving clinical needs while ensuring practitioner comfort. Its sleek, modern look adds sophistication to any office. Experience efficiency and enduring quality with the Evogue Traditional Delivery System.



Your Toolkit for Dental Excellence.

Empowering a higher standard of care.

From the initial concept to the final product, every aspect of the EVG Delivery System has been carefully considered to ensure optimal performance and user experience. Crafted with a seamless blend of convenience, accessibility, and modern design, the EVG Delivery System is tailored to meet the demands of today's bustling dental practices, setting a new benchmark for efficiency and functionality.

With easily accessible chair controls for swift adjustments, a pivoting head to accommodate diverse treatment angles, and a recessed HP holder bar ensuring organized tool storage, the EVG offers dentists unparalleled levels of efficiency, precision, and comfort in their daily practice. It's a comprehensive solution designed to elevate every aspect of dental care, empowering dentists to deliver exceptional treatment outcomes with confidence and ease.



Assystant's VAC PAC



The assistant instrument arm hose tender on traditional over-the-patient delivery models keep vacuum and syringe hoses off the floor, promoting a clean and tidy workspace.



Optional accessories, such as a micromotor, handpiece fiberoptics, and scaler can be seamlessly integrated onto the delivery head, reducing operator clutter.



Effortless Operation, Exceptional Results.

The EVOGUE Delivery System shines with its pivoting doctor table, offering unparalleled ease and flexibility during procedures. Easy access to HP controls ensures swift adjustments, keeping procedures running smoothly. Strategically positioned assistant instrumentation and individual handpiece holders optimize ergonomics and accessibility. This cohesive integration streamlines operations, boosting productivity and enhancing patient care.



Diverse Mounting Solutions, Versatile Operating Capabilities.

PMU mount



Right handed

Swing mount



Right handed

Left handed

Chair Mounting Solutions to Fit Your Practice.

EVG Delivery Systems offer a range of chair mounting options designed to meet the diverse needs of every dental practice. Choose the over the patient delivery configuration for a classic setup with optional cuspidor, or opt for the left-right swing mount for unmatched adaptability, accommodating both left- and right-handed dentists. These choices prioritize comfort and efficiency, enhancing overall functionality and flexibility.



Make the most of your space.

For practices focused on the optimization of treatment room space, the cabinet mount option seamlessly integrates into any layout, catering to practitioners of all handedness. This versatile choice enhances workflow and organization, while elevating the space's functionality and aesthetics.





Specification

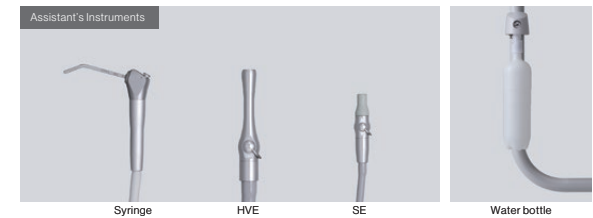

Delivery Systems	Traditional Style
Convenient chair control touch pad	●
Tray holder (size: 290 x 190 mm)	-
Handpiece holder positions	3+ Syringe
Handpiece instruments	●
- 3x Midwest 4 holes turbine hose	(standard spec)
- 1x Air/Water syringe	●
Midwest 4-hole turbine hose with fiber optic	○
Bien Air micromotor system	○
Cavitron magnetostrictive scaler	○
Acteon SP Newtron piezo scaler with LED	○
Acteon SP Newtron piezo scaler without LED	○
Left/right conversion (swing mount delivery only)	●
Balance arm with air brake	●
2 Brake handles	●
Flushing system	●
Water system (2L bottle)	●
Junction box	●
Wet/Dry Foot Control	●

Assistant's Systems	
Left/right conversion (swing mount delivery only)	●
Breakaway assistant arm	●
Handpiece instruments	●
- 1x high volume evacuation (HVE)	●
- 1x saliva ejector (SE)	●
- 1x Air/Water syringe	●
- 1x option (2nd HVE)	○
Rotating cuspidor bowl, porcelain (OTP delivery only)	○
1/4 Water Quick Disconnect with outlet flow control	●
1/4 Air Quick Disconnect	●

Accessories	
Monitor swing arm and mount (swing mount delivery only)	○

● standard ○ option

Be

Evogue Mobile Cart **Delivery Systems**

Experience unparalleled versatility and convenience with the EVOGUE Dental Cart.

Discover the EVOGUE Dental Cart, an innovative solution designed to elevate efficiency and flexibility in dental practices. With its mobility and compact footprint, the EVOGUE offers seamless movement and positioning within any treatment room, optimizing space and workflow.

Easy access to essential tools and instruments promotes efficiency, streamlining procedures for dental professionals. This mobile delivery cart creates new opportunities in modern dentistry.





Streamlined Efficiency for Modern Practices

Maximizing Space, Enhancing Workflow.

Dental carts are indispensable assets in treatment rooms, boasting numerous advantages such as cost-effectiveness and versatility. Their compact design and efficient nature help maximize every square foot, making them ideal for clinics with limited space. Beyond space optimization, their streamlined design and mobile capabilities enhance workflow and accessibility, enabling doctors to bring all essential tools within reach.

The EVOGUE Mobile Delivery Cart enhances workflow through its seamless, accessible, and compact design, fostering closer interactions with patients and promoting a more efficient and patient-friendly environment. Its efficient and mobile design enables practitioners to navigate procedures effortlessly while upholding exceptional standards of patient care. The combination of practicality and mobility makes this delivery cart an essential resource for modern dental practices.





Enhanced Efficiency.

Unleash the full potential of your dental practice with the EVOGUE Cart. Designed to enhance functionality and efficiency, this robustly engineered cart is your ultimate solution for a seamless workflow and superior patient care.

The EVOGUE features a sturdy surface for a stainless-steel tray to keep instruments organized, an optional shelf for rheostat controls, durable casters for optimal mobility, and all the essentials to position your practice for success.





Specification



Replacement Doctor Table Cover
With Seat Positioning Control Touchpad Option



Foot Control Storage Shelf
Option



Water bottle



Bien Air MX2 PLUS

Cavitron

Acteon SP Newtron
piezo scaler with LED

Acteon SP Newtron
piezo scaler without LED

Delivery Systems	Traditional Style
Convenient chair control touch pad	<input type="radio"/>
Handpiece holder positions	3+ Syringe
Handpiece instruments	<input checked="" type="radio"/>
- 3x Midwest 4 holes turbine hose	(standard spec)
- 1x Air/Water syringe	
Midwest 4-hole turbine hose with fiber optic	<input type="radio"/>
Micro motor	<input type="radio"/>
Cavitron magnetostrictive scaler	<input type="radio"/>
Acteon SP Newtron piezo scaler with LED	<input type="radio"/>
Acteon SP Newtron piezo scaler without LED	<input type="radio"/>
Flushing system	<input checked="" type="radio"/>
Water system (2L bottle)	<input checked="" type="radio"/>
Junction box	<input type="radio"/>
Wet/Dry Foot Control	<input checked="" type="radio"/>
1/4 Water Quick Disconnect with outlet flow control	<input type="radio"/>
1/4 Air Quick Disconnect	<input type="radio"/>

● standard ○ option



Est. 1921

Advancing Dental Care with Quality & Experience

 **Belmont**

Belmont Equipment
Takara Company Canada Ltd.

101 Belmont Drive, Somerset, NJ 08873
2455 Meadowvale Boulevard, Mississauga, Ontario, L5N 5S2

(800) 223-1192 www.belmontequip.com

(800) 268-5351 www.belmont.ca

The specifications and colors are subject to change without notice.