



ProIII

Dental Chair Package

The chair that supports everyone in the office.



PROIII
Multi Purpose Dental Chair

Evogue Mobile Cart
Delivery System

Scan for other brochures

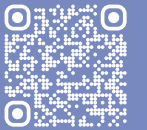



The chair that supports everyone in the office.

Experience the ultimate in dental comfort and functionality with the Pro III Dental Chair.

Introducing the Pro III Dental Chair—a revolutionary blend of comfort, innovation, and functionality that sets a new standard in dental care. Designed with the practitioner and patient in mind, the Pro III seamlessly combines advanced ergonomics with intuitive features to deliver an unparalleled experience. The Pro III redefines what it means to provide exceptional dental care. It's a chair that supports everyone in the office, ensuring both practitioners and patients alike feel comfortable and confident throughout every appointment.

Be

ProIII
Dental Chair

Unique functions rotation and knee break

From its easy patient entry and exit to its efficient use of space and transformative versatility, the Pro III enhances every aspect of the dental experience. With features like swing-out armrests, extending legrest, and dual-articulating headrest, it ensures unparalleled comfort and support for patients of all heights and needs. Its aseptic hands-free control and 240-degree rotation further optimize operator efficiency, while its ideal seating position for diagnostics guarantees accurate assessments and treatment outcomes. Elevate your practice with the Pro III Dental Chair and discover the perfect blend of comfort, innovation, and excellence—all in one chair.



Sitting Position



Reclining Position

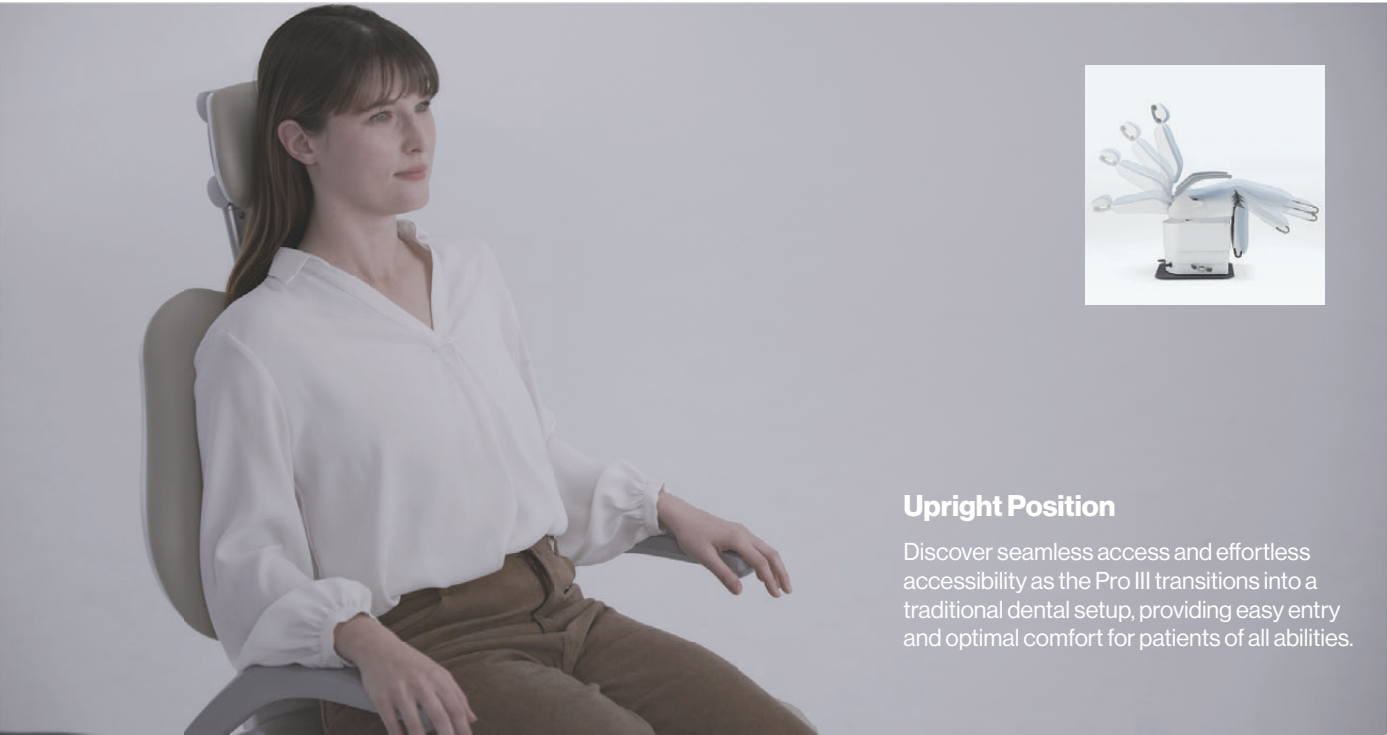

Upright Position

Discover seamless access and effortless accessibility as the Pro III transitions into a traditional dental setup, providing easy entry and optimal comfort for patients of all abilities.



Reclined Positions

Relax into supreme comfort as the leg rest extends and the chair reclines, ensuring continuous support and promoting a comfortable treatment experience.



Exceptional capabilities, all around versatility.

Experience unparalleled flexibility and convenience with the Pro III Dental Chair's effortless rotation capabilities. With a 240-degree rotation range, practitioners can effortlessly position the chair for convenient patient entry, relaxed face-to-face consultations, and seamless examinations from multiple angles.

This seamless rotation not only enhances practitioner to patient interactions but also fosters a calming environment conducive to patient comfort and trust. Whether engaging with patients during consultations or performing intricate procedures, the Pro III's rotation feature ensures optimal positioning for every stage of dental care.



**At 6:00 position,
The upright seating position
enables doctors to stand in front
of a seated patient, where doctors
can perform examinations in a
natural, upright position.**

This supports everything from temporomandibular joint disorder exams to denture and invisalign scans.



**At 9:00 position,
Doctors can pivot patients into an
ideal position to view diagnostics
and other treatment information.**

This position creates a caring and supportive environment, where patients can invite a friend or family member to join for emotional support.



**At 10:00 position,
Doctors and staff can position the chair
in a more familiar way to create a welcoming
and comfortable environment for patients.**

This position is also ideal for face-to-face consultations to help reduce patient anxiety.





Reassuring Qualities.

Optimized for accessibility, the Pro III dental chair features rotating armrests that enhance the patient care experience. These user-friendly armrests elevate the patient entry and exit experience, facilitating smoother movement and alleviating strain for both patients and dental staff.

Designed for durability and stability, the armrests accommodate patients of all ages and mobility levels. The chair's upright capabilities and rotating armrests ensure a clearer pathway for patients, regardless of their mode of transportation. This reflects Belmont's commitment to inclusivity and exceptional dental care.

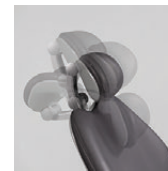

Oral Cavity Access.

The dual-articulation mechanism of the Belmont headrest enables precise adjustments, providing optimal neck and head support to enhance patient comfort throughout a variety of dental procedures, especially beneficial for longer treatments. Additionally, it improves dentist access and visibility, improving efficiency and contributing to overall treatment success.

Belmont
CHAIRLOVE

Closer to your patients, Closer to your goals.

Are you prepared to elevate your patient care experience and strengthen connections with your patients?

Experience the Pro III Dental Chair—an embodiment of comfort, efficiency, and patient-centered care. With its innovative design, the Pro III chair brings you closer to your patients and supports your goals, transforming every treatment room into a sanctuary of comfort and excellence.

Imagine a dental chair that not only meets the practical demands of dentistry but also enhances the patient experience at every touchpoint. The Pro III achieves this seamlessly, with features designed to foster deeper connections and improve patient comfort. From effortless patient access to seamless communication, every aspect of the Pro III is crafted to create a personalized and memorable interaction.

As your patients relax into the plush cushions and experience the smooth movement provided by the Pro III, they'll feel valued, understood, and well-cared for. And as a dentist, you'll appreciate the chair's user-friendly design, which enhances your ability to perform procedures efficiently without sacrificing patient comfort.

The Pro III isn't just a chair—it's a symbol of your commitment to excellence and your dedication to delivering the highest standard of care. It stands as a testament to your unwavering pursuit of success and fulfillment in your practice.

With the Pro III, you're investing in more than just equipment; you're fostering deeper connections with your patients and creating a brighter future for your practice. Get ready to elevate your practice with the Pro III Dental Chair—where every patient interaction leaves a lasting impact.

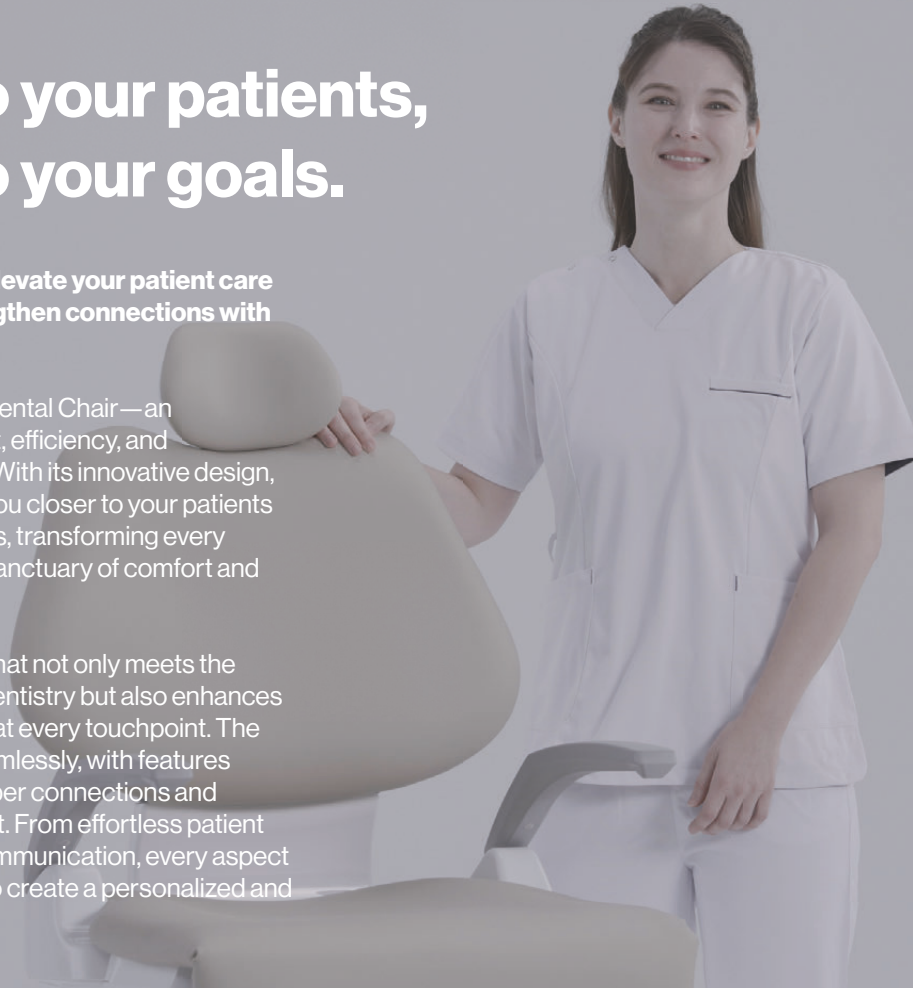

Belmont Quality.



Assured Quality.

Our commitment to superior quality and performance is evident in the manufacturing of our hydraulic cylinders, vital components in our dental chairs. These cylinders undergo meticulous engineering to deliver smooth, precise movements crucial for patient comfort and effective procedures, meeting the industry's highest standards. Since the 1970s, only chairs that have passed our rigorous 100,000-cycle durability test have been produced, ensuring long-lasting performance in dental offices worldwide.

Our hydraulic system operates with fewer components, minimizing the risk of malfunctions and ensuring consistent quality over time. Unlike many in the industry who rely on outsourced parts, we manufacture every component ourselves, guaranteeing the highest precision and quality. From minor fittings to critical elements like the hydraulic cylinder, each piece is crafted in-house, ensuring unmatched quality and reliability. This dedication reinforces Takara Belmont's reputation as a global leader in dental equipment, known for seamlessly blending innovation and tradition in every product.



Customized for your workspace, one stitch at a time.

Discover the unparalleled quality and value of UltraLeather, Allante Free, and Maverick upholsteries — available in various styles to elevate any setting. These options represent the pinnacle of craftsmanship and design in upholstery.

Each line enhances the decor and delivers tangible benefits tailored to meet diverse preferences and demands, ensuring satisfaction across various applications. These materials provide distinctive solutions for upholstery needs.

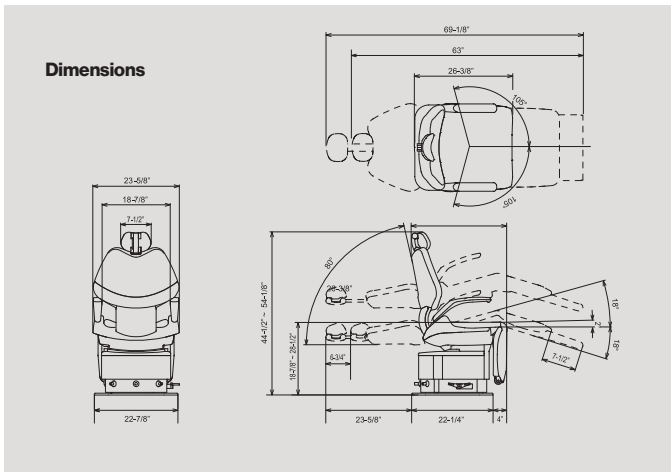

ULTRALEATHER®



STANDARD VINYL ALLANTE FREE®

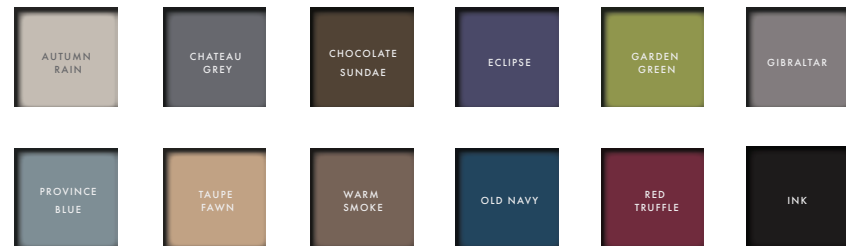

MAVERICK MORCLEAN®

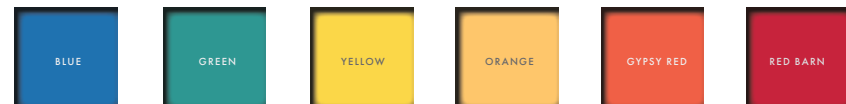

UltraLeather combines luxury and resilience, making it perfect for high-traffic settings. Its superior durability ensures long-lasting elegance and performance, maintaining its pristine condition under demanding use.

Allante Free stands out with its eco-friendly, PVC-free design. It offers a sustainable option without sacrificing leather-like finesse and texture. It's ideal for those seeking environmentally conscious materials with luxury.

Maverick offers a robust yet elegant aesthetic, ideal for stylish and utilitarian environments. Its sophisticated look enhances any décor, blending durability with a refined appearance that appeals to modern tastes.

Be

Evogue Mobile Cart **Delivery Systems**

Experience unparalleled versatility and convenience with the EVOGUE Dental Cart.

Discover the EVOGUE Dental Cart, an innovative solution designed to elevate efficiency and flexibility in dental practices. With its mobility and compact footprint, the EVOGUE offers seamless movement and positioning within any treatment room, optimizing space and workflow.

Easy access to essential tools and instruments promotes efficiency, streamlining procedures for dental professionals. This mobile delivery cart creates new opportunities in modern dentistry.





Streamlined Efficiency for Modern Practices

Maximizing Space, Enhancing Workflow.

Dental carts are indispensable assets in treatment rooms, boasting numerous advantages such as cost-effectiveness and versatility. Their compact design and efficient nature help maximize every square foot, making them ideal for clinics with limited space. Beyond space optimization, their streamlined design and mobile capabilities enhance workflow and accessibility, enabling doctors to bring all essential tools within reach.

The EVOGUE Mobile Delivery Cart enhances workflow through its seamless, accessible, and compact design, fostering closer interactions with patients and promoting a more efficient and patient-friendly environment. Its efficient and mobile design enables practitioners to navigate procedures effortlessly while upholding exceptional standards of patient care. The combination of practicality and mobility makes this delivery cart an essential resource for modern dental practices.





Enhanced Efficiency.

Unleash the full potential of your dental practice with the EVOGUE Cart. Designed to enhance functionality and efficiency, this robustly engineered cart is your ultimate solution for a seamless workflow and superior patient care.

The EVOGUE features a sturdy surface for a stainless-steel tray to keep instruments organized, an optional shelf for rheostat controls, durable casters for optimal mobility, and all the essentials to position your practice for success.





Specification

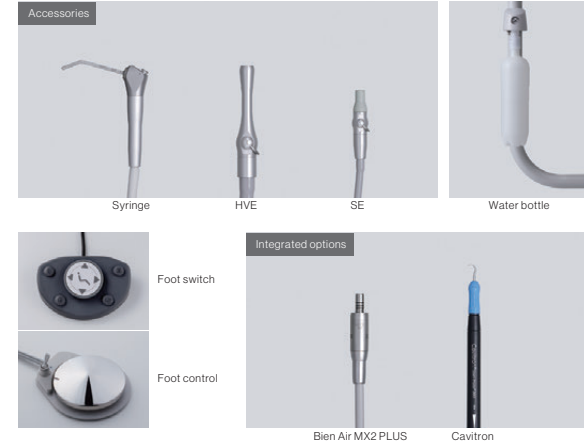

Delivery Systems	Traditional Style	Flex Continental style
Convenient chair control touch pad	●	●
Tray holder (size: 290 x 190 mm)	-	-
Handpiece holder positions	3+ Syringe	3+ Syringe
Handpiece instruments		
- 3x Midwest 4 holes turbine hose	● (standard spec)	● (standard spec)
- 1x Air/Water syringe		
Midwest 4-hole turbine hose with fiber optic	○	○
Micro motor	○	○
Cavitron magnetostrictive scaler	○	○
Left/right conversion	●	●
Balanced flex arm with air brake	●	●
2 Brake handles	●	●
Flushing system	●	●
Water system (2L bottle)	●	●
Junction box	●	●
Wet/Dry Foot Control	●	●

Assistant's Systems	PMU	Vac.Pac
Left/right conversion		
Breakaway assistant arm	●	●
Handpiece instruments		
- 1x high volume evacuation (HVE)		
- 1x saliva ejector (SE)	●	●
- 1x Air/Water syringe		
- 1x option (2nd HVE)		
Rotating cuspidor bowl, porcelain	○	-
1/4 Water Quick Disconnect with outlet flow control	●	●
1/4 Air Quick Disconnect	●	●

Accessories		
Monitor bracket	○	-

● standard ○ option

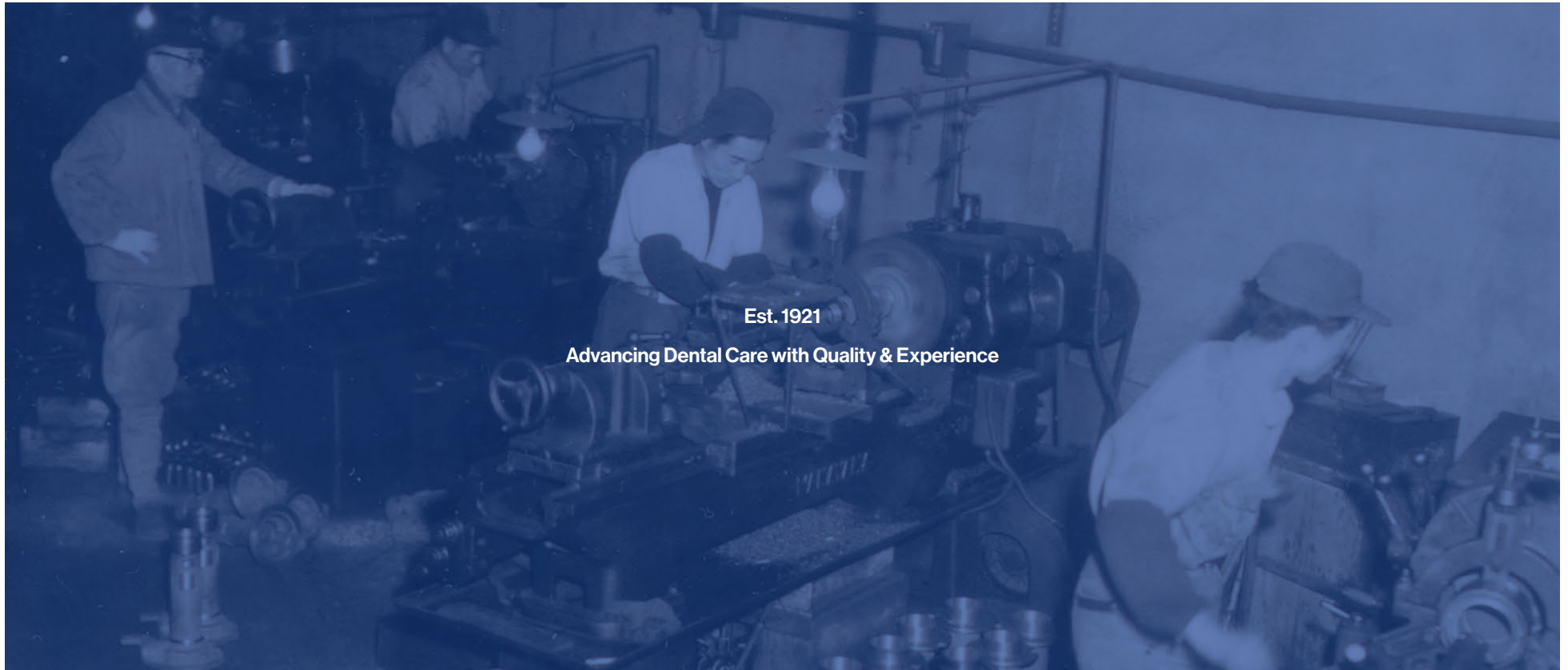

Est. 1921

Advancing Dental Care with Quality & Experience

 **Belmont**

Belmont Equipment
Takara Company Canada Ltd.

101 Belmont Drive, Somerset, NJ 08873
2455 Meadowvale Boulevard, Mississauga, Ontario, L5N 5S2

(800) 223-1192 www.belmontequip.com

(800) 268-5351 www.belmont.ca

The specifications and colors are subject to change without notice.