



# Q5500

## Premium Dental Chair Package

The only chair  
worthy of the center stage.



**Q5500**  
Dental Chair

**Evogue Flex**  
Delivery System

**Bel Halo**  
Dental Light

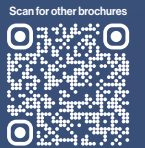

# The only chair worthy of the center stage.

## Exceptional Craftsmanship. Unsurpassed Quality.

The QUOLIS Q5500 dental chair sets the stage for excellence through exceptional craftsmanship and unsurpassed quality. Beyond its sleek and refined appearance, the Q5500 elevates the experience of both patients and practitioners alike. This sophisticated dental chair embodies a perfect harmony of intuitive design, user-friendly controls, and unmatched comfort.

Reassuring through unparalleled comfort, the Q5500 carries advanced capabilities for an exceptional experience. It features a seat positioning system that effortlessly glides patients into treatment positions. With its thin and narrow backrest design, practitioners gain unrestricted clinical access to work comfortably, efficiently, and effectively.

Take your practice to the center stage of excellence.



# Be

## Q5500

Premium Dental Chair



## **Maximize efficiency, elevate care.**

Designed for an elevated level of care and engineered to enhance dental procedures, the Q5500 dental chair boasts smooth operation, illuminated controls, and a contoured backrest for maximum comfort and accessibility.

The dual-articulating headrest adjusts seamlessly, ensuring continuous support throughout treatment. Crafted with a focus on patient comfort and practitioner ease, the Q5500 Dental Chair enriches the dental experience, making it an indispensable addition to your practice.



### **Intuitive Controls.**

The Q5500 chair is equipped with membrane touchpad controls on both the doctor's and assistant's sides, allowing for easy chair adjustments. This allows precise control over vertical and reclining movements, with a locking feature for 120-degree rotation of the chair base.



### **Oral Cavity Access.**

The dual-articulation mechanism of the Belmont headrest enables precise adjustments, providing optimal neck and head support to enhance patient comfort throughout a variety of dental procedures, especially beneficial for longer treatments. Additionally, it improves dentist access and visibility, improving efficiency and contributing to overall treatment success.



### **Superior Access.**

The Q5500 chair's thin, narrow backrest is designed for optimal dentist access to the patient's oral cavity, ensuring precise and effortless procedures. Its streamlined design promotes closer positioning, reducing strain on the dentist and improving ergonomic access for both routine and complex dental work.



## **Smooth Operation, Seamless Movements.**

The Q5500 chair delivers smooth operation and powerful performance. Its shockless solenoids provide gentle and seamless movements, enhancing patient comfort and practitioner control during adjustments. This advanced technology provides a reliable, high-performance chair tailored to the dynamic needs of modern dental practices.

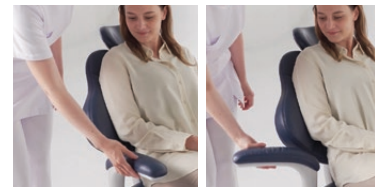

## **Reassuring Qualities.**

The user-friendly arm rotation feature facilitates smoother patient entry and exit, alleviating strain for both patients and dental staff. Designed to endure frequent use while ensuring stability, these arms are ideal for accommodating patients of all ages and mobility levels.

**Thoughtfully designed with  
your needs in mind.**

Crafted to meet the highest standards of modern dentistry, our chairs offer four distinct styles, each tailored to your unique clinical environment and comfort needs. Each style is thoughtfully designed to cater to the unique ergonomic and aesthetic needs of today's dental practices.





Belmont  
**CHAIRLOVE**

## **Better Patient Care Starts with a Better Patient Chair.**

---

**Do you aspire to redefine the patient experience  
and lead your dental practice in exceptional  
care?**

With the Q5500 Dental Chair, you can turn your vision into reality. Patients will feel at ease with the Q5500 Dental Chair's thin, narrow backrest and precise adjustments, while you'll appreciate its user-friendly design and efficiency-boosting features.

Throughout your day, the chair's dual-articulating headrest will prove invaluable, providing unmatched support during lengthy procedures and enhancing overall comfort. Patient feedback will highlight the chair's impact, with praises for the contoured backrest's spine support and the dual articulating headrest's relief from neck strain.

As patients leave with smiles, it will become evident that the Q5500 is more than just a chair—it's an essential part of your practice. By day's end, the Q5500 will seamlessly integrate into your workflow, enhancing patient comfort and your efficiency. With its user-friendly design and unwavering focus on comfort and accessibility, the Q5500 Dental Chair plays a pivotal role in elevating your practice to a new level of excellence.



# Belmont Quality.

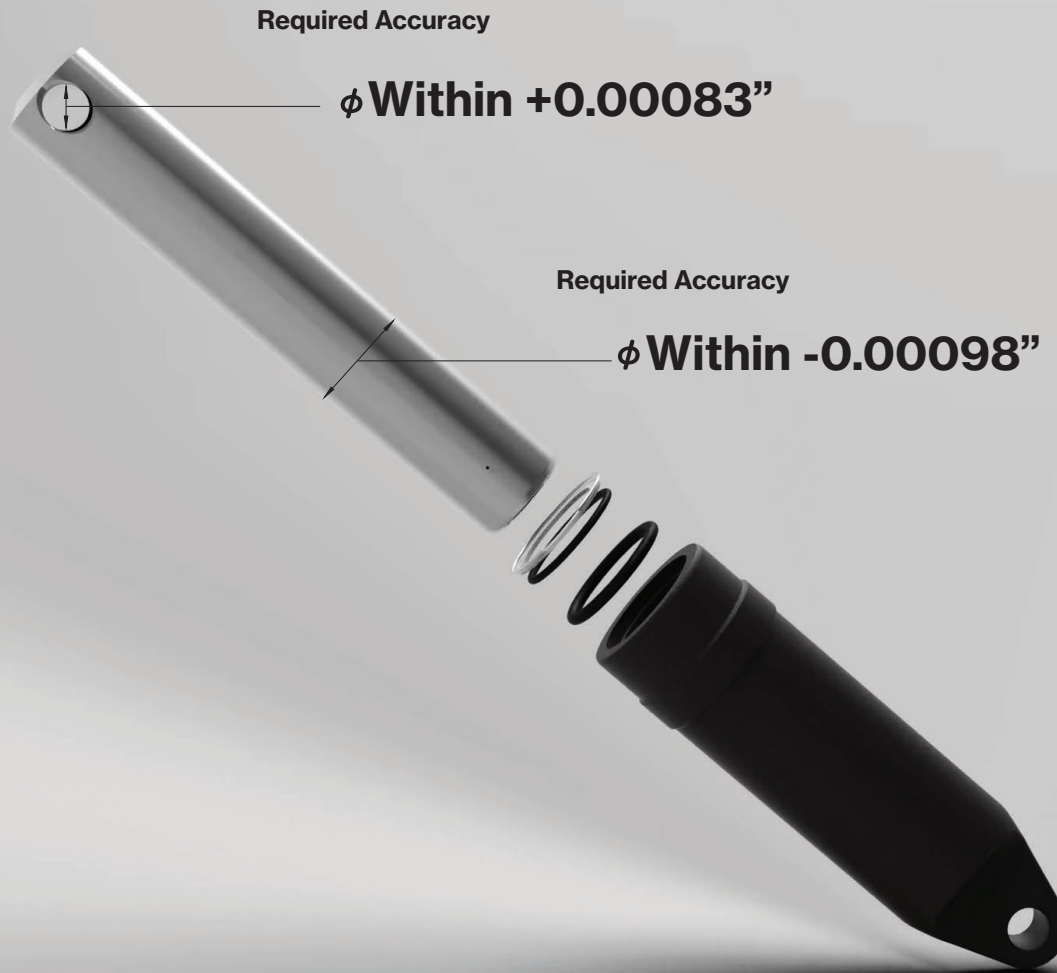

## Assured Quality.

Our commitment to superior quality and performance is evident in the manufacturing of our hydraulic cylinders, vital components in our dental chairs. These cylinders undergo meticulous engineering to deliver smooth, precise movements crucial for patient comfort and effective procedures, meeting the industry's highest standards. Since the 1970s, only chairs that have passed our rigorous 100,000-cycle durability test have been produced, ensuring long-lasting performance in dental offices worldwide.

Our hydraulic system operates with fewer components, minimizing the risk of malfunctions and ensuring consistent quality over time. Unlike many in the industry who rely on outsourced parts, we manufacture every component ourselves, guaranteeing the highest precision and quality. From minor fittings to critical elements like the hydraulic cylinder, each piece is crafted in-house, ensuring unmatched quality and reliability. This dedication reinforces Takara Belmont's reputation as a global leader in dental equipment, known for seamlessly blending innovation and tradition in every product.



**Customized for your workspace, one stitch at a time.**

Discover the unparalleled quality and value of UltraLeather, Allante Free, and Maverick upholsteries — available in various styles to elevate any setting. These options represent the pinnacle of craftsmanship and design in upholstery.

Each line enhances the decor and delivers tangible benefits tailored to meet diverse preferences and demands, ensuring satisfaction across various applications. These materials provide distinctive solutions for upholstery needs.

**Dimensions**

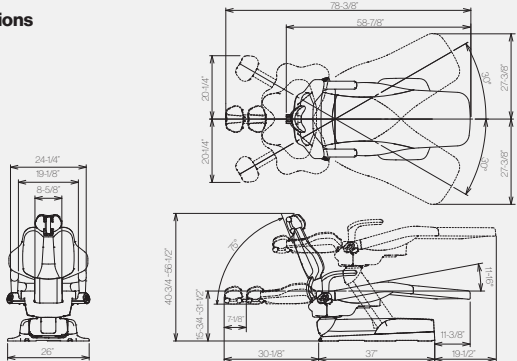

**ULTRALEATHER®**



**STANDARD VINYL ALLANTE FREE®**



**MAVERICK**



UltraLeather combines luxury and resilience, making it perfect for high-traffic settings. Its superior durability ensures long-lasting elegance and performance, maintaining its pristine condition under demanding use.

Allante Free stands out with its eco-friendly, PVC-free design. It offers a sustainable option without sacrificing leather-like finesse and texture. It's ideal for those seeking environmentally conscious materials with luxury.

Maverick offers a robust yet elegant aesthetic, ideal for stylish and utilitarian environments. Its sophisticated look enhances any décor, blending durability with a refined appearance that appeals to modern tastes.

# Be

## **Evoque Flex**

### **Delivery Systems**

---

Uncover unrivaled efficiency with the EVOGUE Flex delivery system—a meticulously crafted solution for an successful dental practices. This industry-leading system boasts intuitive controls and customizable configurations, ensuring every tool is easily accessible. With its ergonomic design and adaptable arm, the delivery system seamlessly adjusts to any treatment scenario, optimizing workflow efficiency and enhancing patient comfort. Embrace the precision and versatility of the Evoque Flex Delivery System to elevate your practice and embrace the future of dental care.





Feel like zero gravity,  
 lower fatigue,  
 higher performance.

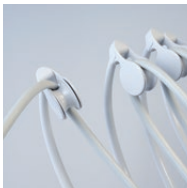

EVOGUE Flex

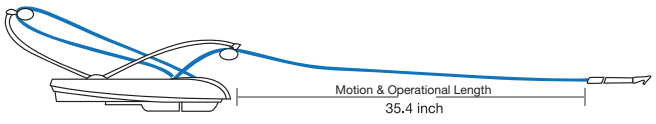

Discover a new realm of accessibility with the Evogue Flex Delivery System, setting a new standard in dental care. Its cutting-edge design extends the reach of dental tools, ensuring effortless access and maximizing efficiency and comfort during every procedure. With its innovative features and superior performance, the Evogue Flex surpasses competitors, establishing itself as an indispensable asset for any modern dental practice.

Competitor

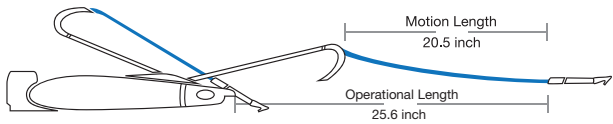

Experience the comfort and ease of operation with the EVOGUE Flex's innovative system that makes dental instruments feel like there is zero gravity. Precisely-engineered to diminish fatigue and amplify accuracy, this delivery system facilitates fluid, seamless movement throughout treatments. Its ergonomic design promotes natural motions, reducing strain and optimizing control. Upgrade to the Evogue Flex Delivery System to transform your practice with seamlessly integrated technology, empowering you to excel in your professional endeavors.



**Effortless Adjustments,  
Unimpeded Movement.**

Effortlessly adjust the system's rotating delivery head to place the table in familiar, patient-friendly positions—pivot the tray or table to maximize your access. This valuable feature eliminates tubing pullback, ensuring smooth and unimpeded movement. For maximum support, the tray can be adjusted into various positions enhancing both comfort and efficiency.

Explore the freedom and precision of the Evogue Flex, expertly crafted to achieve unparalleled.



## Different mounting options

### PMU mount

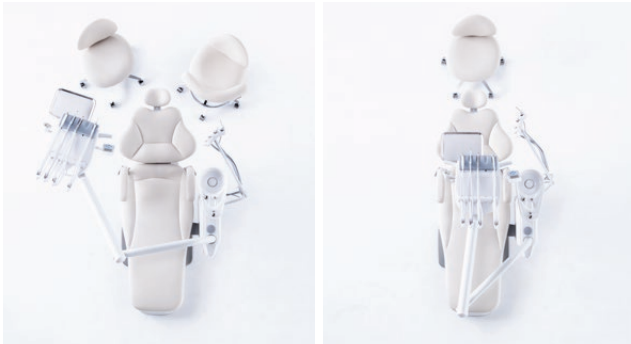

Traditional style positioning/ 4 hands

European style positioning/ 2 hands

### Swing mount



Right handed/ 2 hands

Left handed/ 4 hands

The Evogue Flex Delivery System is a strategic investment for any dental practice. Offering two versatile mounting options, it seamlessly adjusts to different treatment room setups, ensuring smooth integration and optimal functionality in diverse environments. Beyond improving efficiency and aesthetics, it delivers consistent performance and unwavering support in every setting. Unlock your practice's full potential with the Evogue Flex, a system that adapts to your needs, propelling your dental practice towards greater success.



Traditional style positioning/ 4 hands



Traditional style positioning/ 4 hands

### Adaptive Mounting Solutions, Versatile Operating Capabilities.

The left-right swing mount feature of the Evogue Flex is ideal for dental practices that have multiple providers. This innovative feature enables effortless adjustment between left and right-handed operations, ensuring comfort and efficiency for all dentists, regardless of their dominant hand. By accommodating diverse working styles, the Evogue Flex streamlines workflow and minimizes setup time, a significant advantage for bustling, multi-provider clinics.

The adaptable left-right swing mount of the Evogue Flex is tailored to meet the unique requirements of each provider in a shared workspace, fostering an ergonomic and comfortable work setting while optimizing the utilization of treatment areas. Providers can seamlessly personalize the setup to suit their preferred orientation, ensuring optimal access and control during procedures, ultimately enhancing the standard of patient care.

# Durability Test 500,000+.

**10** times per treatment  
**x10** times per day  
**x250** days per year  
**x20** years

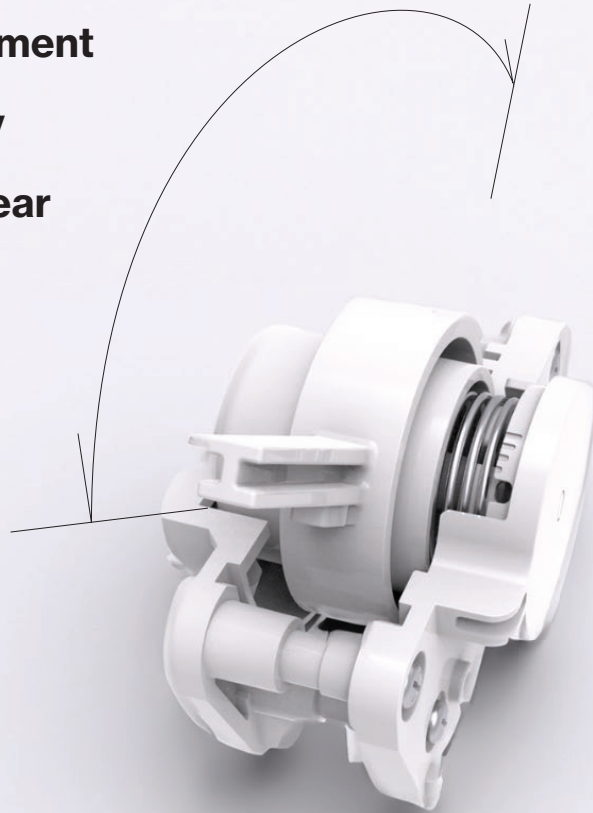

## Quality Assured.

The Evogue Flex Delivery System epitomizes quality and reliability, consistently surpassing expectations with its exceptional performance.

We pride ourselves on our extensive evaluation process, which includes rigorous durability tests, operational simulations, and performance assessments, all aimed at upholding the highest standards of excellence.

With a steadfast focus on longevity and dependability, the Evogue Flex offers a reliable solution for all your dental care needs.





## Specification

### Assistant's Instruments

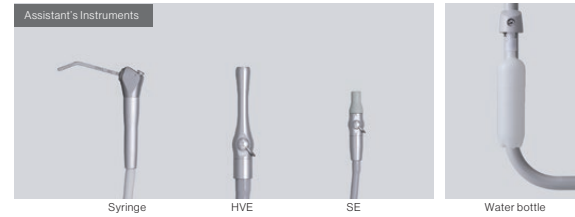

Syringe

HVE

SE

Water bottle

### Integrated options



Bien Air MX2 PLUS

Cavitron

Acteon SP Newton  
piezo scaler with LED

Acteon SP Newton  
piezo scaler without LED

Delivery Systems	Flex Continental style
Convenient chair control touch pad	●
Tray holder (size: 290 x 190 mm)	●
Handpiece holder positions	3+Syringe
Handpiece instruments	●
- 3x Midwest 4 holes turbine hose	(standard spec)
- 1x Air/Water syringe	○
Midwest 4-hole turbine hose with fiber optic	○
Bien Air micromotor system	○
Cavitron magnetostriuctive scaler	○
Acteon SP Newton piezo scaler with LED	○
Acteon SP Newton piezo scaler without LED	○
Left/right conversion (swing mount delivery only)	●
Balance arm with air brake	●
2 Brake handles	●
Flushing system	●
Water system (2L bottle)	●
Junction box	●
Wet/Dry Foot Control	●

Assistant's Systems	
Left/right conversion (swing mount delivery only)	●
Breakaway assistant arm	●
Handpiece instruments	●
- 1x high volume evacuation (HVE)	●
- 1x saliva ejector (SE)	●
- 1x Air/Water syringe	○
- 1x option (2nd HVE)	○
Rotating cuspidor bowl, porcelain (OTP delivery only)	○
1/4 Water Quick Disconnect with outlet flow control	●
1/4 Air Quick Disconnect	●

Accessories	
Monitor swing arm and mount (swing mount delivery only)	○

● standard ○ option





# Be

## **Bel-Halo** Dental Light

---

### **Shining a Light on Excellence**

Illuminate your workspace with the Bel-Halo Dental Light, crafted to deliver precision and comfort throughout procedures. Its novel halo design delivers superior illumination, ensuring enhanced visibility for intricate treatments. Adjustable intensity settings and a sleek, ergonomic design minimizes eye strain and maximizes focus. Let the Bel-Halo Dental Light illuminate your path to exceptional dental care, shining a light on excellence with every procedure.



## Designed to Empower Exceptional Care.

The Bel-Halo Dental Light leads modern dentistry, reshaping standards with advanced technology. Its unique halo design provides uniform illumination, eliminating shadows and revealing details clearly. Dentists have precise control over the light's intensity, tailoring it seamlessly to the specific requirements of each procedure.

Crafted with ergonomic considerations, the light facilitates smooth movement, seamlessly syncing with the practitioner's movements during intricate procedures. This advanced feature reduces eye strain and improves precision, making the Bel-Halo a vital tool for enhancing visibility and comfort during dental treatment.

## Shadow-free Illumination.

Powered by top-tier LED technology, the Bel-Halo Dental Light delivers shadow-free illumination, guaranteeing precise and uniform lighting throughout the treatment zone. Its shadowless illumination technology allows for uninterrupted lighting to the patient oral cavity, even with a 50% obstruction between the light and patient head.

## Treatment and Composite Safe Modes

The Bel-Halo's Dental Light's composite safe mode prevents premature curing of composite materials, giving dentists more time for precise manipulation before setting. This empowers dentists to deliver superior quality dental care, minimizing procedural risks, maximizing efficiency, and ultimately leading to more successful treatment outcomes.



## Mounting Option

The Bel-Halo Dental Light offers six mounting options: track, ceiling, post, wall, and cabinet, for versatile installation in any dental office. Whether you seek to equip a space with tall 8-to-foot ceilings or need to maximize your space, Belmont offers a wide range of mounting options to bring to the Bel-Halo to your operator.

■ Unit Mount



■ Post Mount



■ Ceiling Mount



■ Track Mount



■ Cabinet Mount



■ Wall Mount



## Dimensions

■ Unit Mount

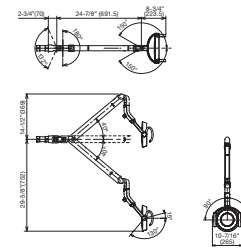

■ Post Mount

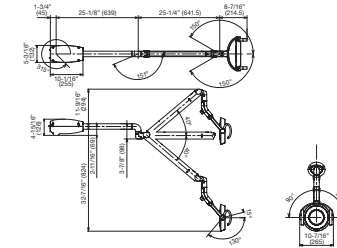

■ Ceiling Mount

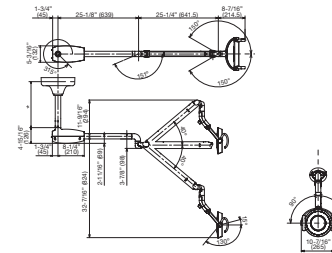

\*Select suspension tube length based upon ceiling height.

■ Track Mount

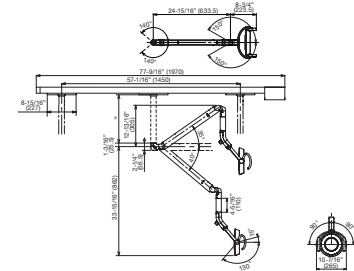

\*Select suspension tube length based upon ceiling height.

■ Cabinet Mount

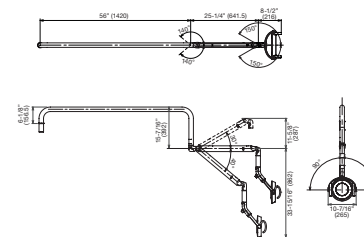

Unit: inch (mm)  
Tolerance in dimensions: ±10%

■ Wall Mount

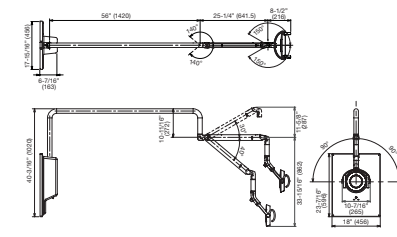



Est. 1921

Advancing Dental Care with Quality & Experience

 **Belmont**

Belmont Equipment  
Takara Company Canada Ltd.

101 Belmont Drive, Somerset, NJ 08873  
2455 Meadowvale Boulevard, Mississauga, Ontario, L5N 5S2

(800) 223-1192 [www.belmontequip.com](http://www.belmontequip.com)

(800) 268-5351 [www.belmont.ca](http://www.belmont.ca)

The specifications and colors are subject to change without notice.