

Installation Instructions & Owners Manual

**E-Series Dental Cabinetry
Model: E-9**

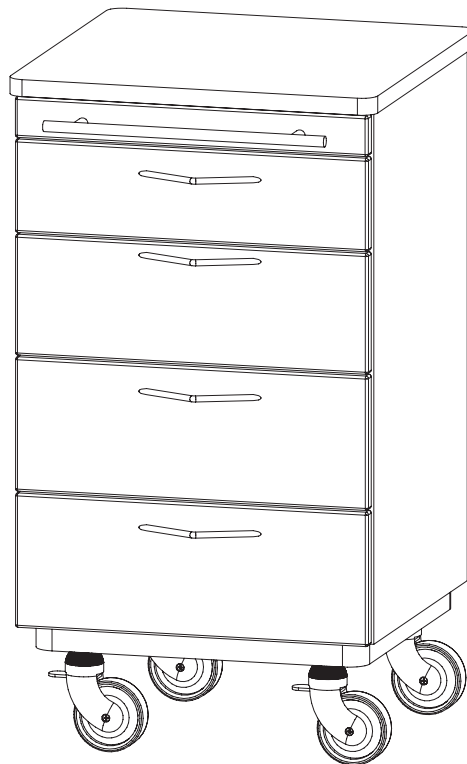

E-9

Consumer: Please retain these instructions for future use.



1631 Dr. Martin Luther King Drive
St. Louis, MO 63106
(314) 231-7383 (888) 833-3682
Fax (314) 621-2296
www.belmontequip.com

Detail Drawings

Model: E-9

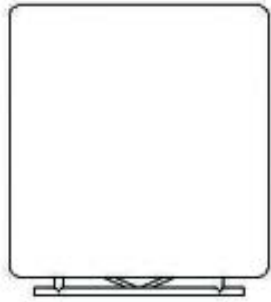

TOP VIEW

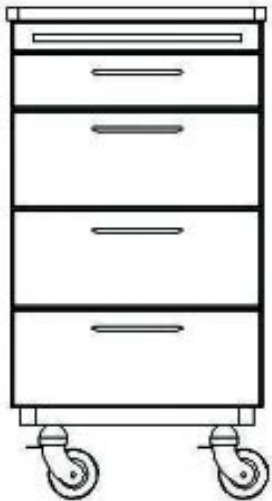

FRONT VIEW

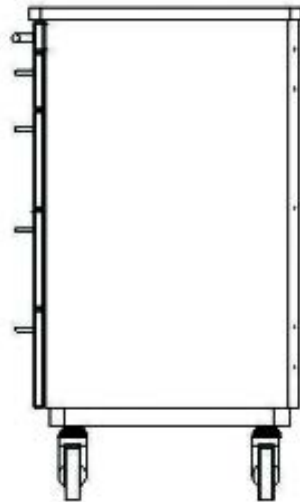

RIGHT SIDE VIEW

Caster Mounting Model: E-9

Do Not Lift Cart
Using Top

Step 1

Tilt & Lay
On Back
x 2 People

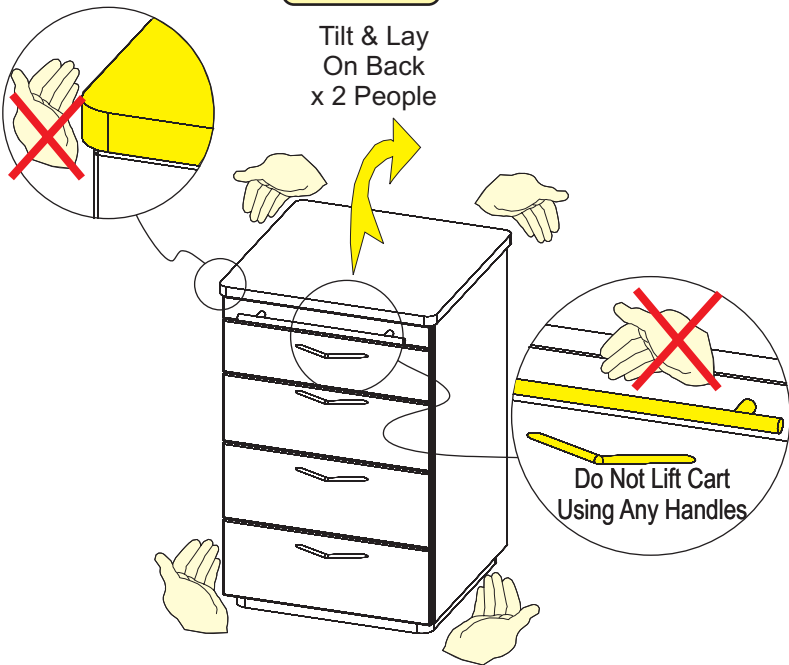

Step 2

Insert threaded bolt
of caster into threaded
insert in bottom of cart and
hand tighten x 4 casters.

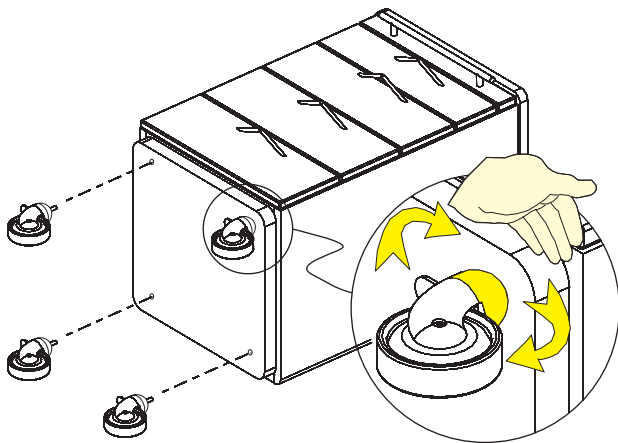

Step 3

Tilt & Set
Upright
x 2 People

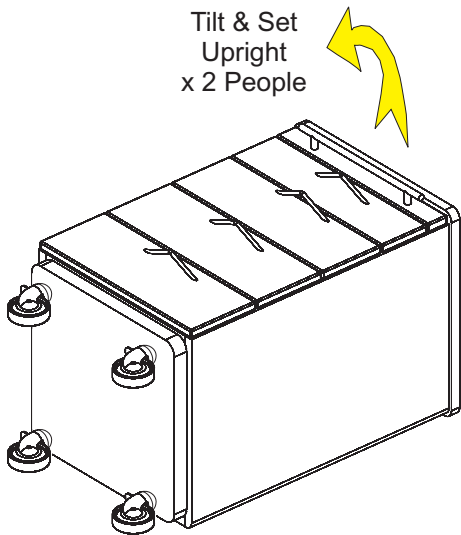

Step 4

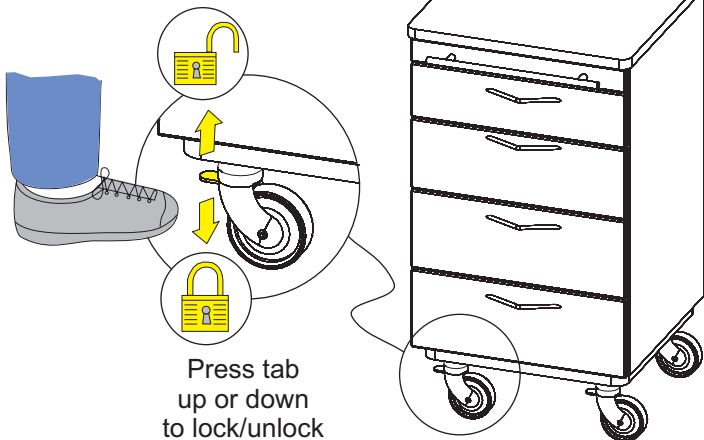

Over time and useage check
casters to make sure they are
tight. Hand tighten if loose.

Drawer Assembly/Removal/Adjustments

Model: E-9

Drawer insertion and removal

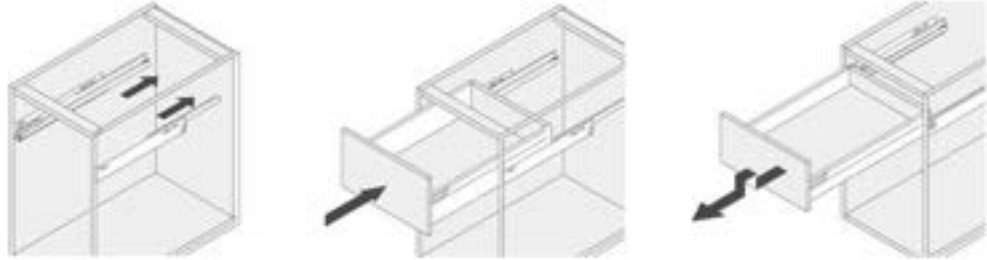

Drawer front attachment and removal

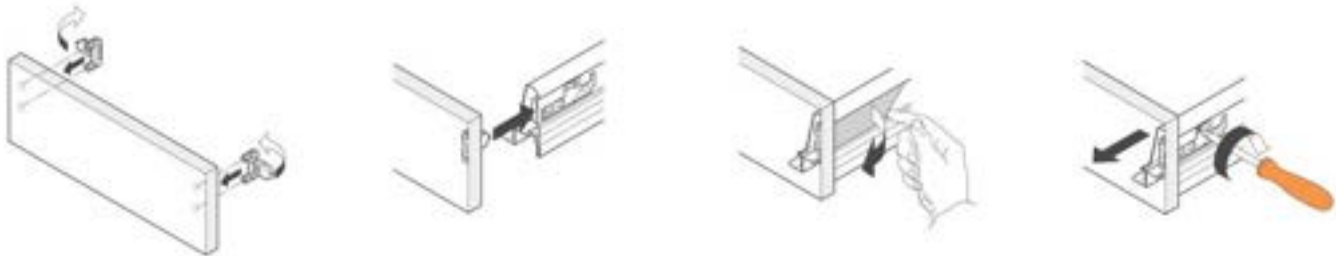

Drawer assembly

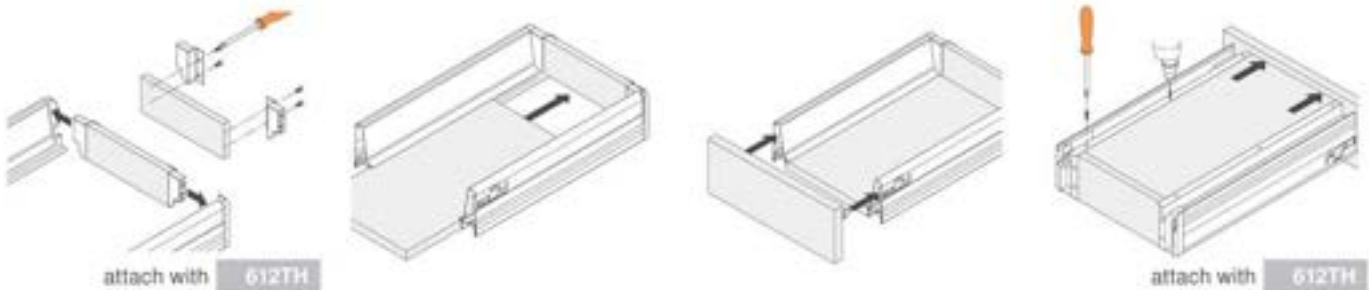

Side adjustment

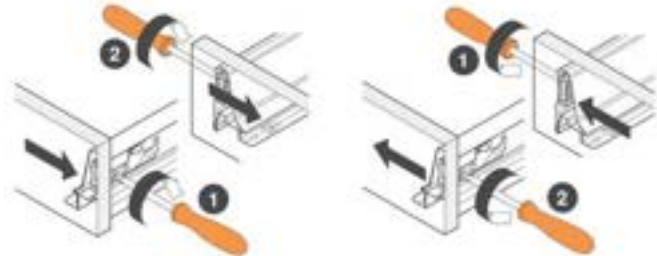

Cam height adjustment

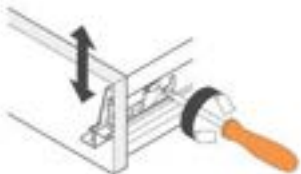

Surface Cleaning

Ortho-Sys. ECO-Sys, D-Series, & E-Series

Belmont Recommends:

- *Countertop Magic*® for Laminate and Solid Surface Work Surfaces
- *Stone Clean and Polish Magic*® for Cambria Quartz Work Surfaces
- *Cabinet and Wood Magic*® for Laminate and Melamine Surfaces
- *Stainless Steel Magic*® for Stainless Steel Surfaces

Products available at Lowes®, Home Depot®, or @ www.magicamerican.com

Laminate/Melamine Surfaces

Clean surfaces with a damp cloth or sponge with a mild soap.

Stains may be removed with most non-abrasive household cleaners such as Formula 409®, Fantastik®, Glass Plus®, or Windex with Ammonia D®.

For tough stains, use a paste of baking soda and water and apply with a soft bristled brush. Although baking soda is a low abrasive, excessive scrubbing or exerting too much force may damage the decorative surface.

Many commercially available products contain substances that may damage or discolor the decorative surface. **Do not** use abrasive cleaners such as toilet bowl cleaners, hydrogen peroxide, oven cleaners, drain cleaners, metal cleaners and polishes, chlorine bleach, coffee pot cleaners, hard water stain removers, fruit and berry juice, tub and tile cleaners, or equivalent.

LG HI-MACS® Solid Surface Tops

Clean surfaces with a damp cloth or sponge with a mild soap.

Stains can easily be removed using a domestic all-purpose cleaner or for tough stains use a bleaching agent (**do not leave in contact with the work surface for more than five minutes**) and rinse with clean water.

Avoid using cleaning agents that contain acids, such as methyl chloride or acetone. Should one of these products accidentally come into contact with the material, as a precautionary measure, rinse the surface with soapy water to prevent any discoloring taking place.

For additional care/maintenance, visit: www.lghausys.com

Cambria® Quartz Work Surfaces

Clean surfaces with a damp cloth or sponge with a mild soap.

Do not use abrasive, strong alkaline, acid, free radicals, or oxidized cleaners (whether high, neutral or low pH). **Do not** use products such as bleach, oven cleaners, Comet®, Soft Scrub®, SOS®, products with pumice, batteries, paint removers, furniture strippers, or tarnish/silver cleaners. **Do not** use abrasive or harsh scrub pads. **Do not** apply sealers, penetrants or topical treatments, as such products will wear off and cause the gloss to appear dull or inconsistent.

For additional care/maintenance, visit: www.cambriausa.com