

Evogue Chair (Model Q3300)
INSTRUCTIONS FOR USE

Dear Customers

Dear Customers

Thank you for purchasing our product.

This booklet explains how to use the Evogue Chair (Model Q3300). Before using the Evogue Chair (Model Q3300), carefully read the operating instructions and make sure to use the product correctly. Using the product without reading these instructions may lead to an accident.

For easy access to the information contained herein, keep this booklet at hand and review it as needed.

Ask your local authorized Belmont dealer to install this product by following the installation instructions contained with this product.

If you have any questions regarding the operating instructions or this product, contact your local authorized Belmont dealer.

If you need a new operating instructions booklet, please request the REF number indicated below to your local authorized Belmont dealer or print manual from our website.

This document describes the full version of the system. It may therefore cover components that are not included in the system you purchased.

2022-01 (1st version)	
REF	1E08APAE

Dear Customers	2
1 General Information	
1-1 Intended Use of the Product	5
1-2 How to Dispose of the Device	5
1-3 Technical Description	5
1-4 Symbols	6
2 Safety Consideration	
2-1 Risk Level Interpretation	7
2-2 Safety Precautions	9
Important points to remember when operating the product	16
2-3 EMC Information	17
3 Precautions for Use	
3-1 Operating Precautions	21
3-2 Precautions for Upholstery	21
4 Product Specifications	
4-1 Technical Data	22
4-2 Name of Each Part	23
5 Operation	
5-1 Preparation Before Use	24
5-2 Operating the switches	26
5-3 Rotating the Seat	28
5-4 Adjusting the headrest position	29
5-5 Rotating the armrests for patient entry/exit	30
5-6 Safety Switch function	31
6 Maintenance and Cleaning	
6-1 Cleaning and disinfection	32
6-2 Maintenance and inspection	34
6-3 Environmental Conditions for Transportation or Packaging	36
6-4 Storage method	36

7 Troubleshooting

7-1	Troubleshooting	37
-----	-----------------------	----

8 Maintenance by Service Engineers

8-1	After-sales service	38
8-2	Service life	38
8-3	Period of Parts Retention	38

9 Accessories and Consumables

9-1	Accessories	39
9-2	Consumables	39

1-1 Intended Use of the Product

This product is an active therapeutic device intended for the exclusive use for diagnoses, treatments and relative procedures of dentistry. The product must be operated or handled by the qualified dentists or by dental staffs under the supervision of the dentist. Such dentists or dental staffs should instruct and/or assist the patients to approach to and leave from the product. Patients should not be allowed to operate or handle the product unless he/she is so instructed.

1-2 How to Dispose of the Device

When disposing of this product and parts replaced, carefully take infection control measures and handle them properly in accordance with the relevant laws and regulations (applicable regulations and local regulations).

1-3 Technical Description





















The following are explained in the documents listed below:

Item	Document
How to install this product	Installation instructions
Wiring/plumbing	Installation instructions

1 General Information

1-4 Symbols

The symbols listed below are used on this product and labels as well as in this booklet. Check the meaning of each symbol.

	Switch (O N)		Switch (O F F)
	Alternating current		Protective earthing
	Name and address of the manufacturer		Year of manufacture
	Catalog number		Caution
	General warning sign		Type B Applied Parts contacting the patient's body surface only
	Follow instructions for use		Generally prohibited activity
	Disassembly, repair or modification prohibited		Instructions for mandatory actions in general
	Indicates that the power plug must be removed from the power outlet		Swivel lock release switch
	Switch for manual operation		Preset switch 1
	Preset switch 2		Preset switch 3
	Automatic return switch		

Precautions before use

2-1 Risk Level Interpretation

Make sure to carefully read the Safety Precautions and Operating Precautions and use the product correctly.

These precautions are intended to ensure the safe use of the product and prevent harm or damage to users or other people.

According to the magnitude of harm and damage and the degree of urgency, an incident that may be caused by misuse of the product is classified into one of the following categories: CONTRAINDICATION, WARNING, and CAUTION.

All of these categories are important for safety. Always follow the instructions provided.

We assume no responsibility for any accident due to failure to follow the Safety Precautions or Operating Precautions even in the event of harm or damage to users or other persons.

Users or other persons who use the product without observing the Safety Precautions and Operating Precautions are responsible for any harm or damage incurred.

The graphical symbols used in these instructions are explained in detail below.

Once you have fully understood these explanations, follow the operating instructions in this booklet.

2 Safety Consideration

Classification by degree of harm or damage and urgency

CONTRAINDICATION

Use of the product without regard to this indication will create a hazardous condition that may result in death or serious injury.



WARNING

Improper handling of the product without regard to this indication will create a hazardous condition that may result in death or serious injury.



CAUTION

Improper handling of the product without regard to this indication will create a potentially hazardous condition that may result in moderate or slight injury or property damage.

The following graphical symbols are used to explain your responsibilities for using the product safely:

Graphical symbols for prohibited activity



Generally prohibited activity



Disassembly, repair or modification prohibited

Graphical symbols for mandatory instructions



Instructions for mandatory actions



Indicates that the power plug must be removed from the power outlet.

2-2 Safety Precautions

CONTRAINDICATION

Installing or transferring the product



Precautions regarding installation

Do not install the product near electromagnetic emission sources such as communication facilities or elevators.

Malfunction of this product may occur when operated in the presence of electromagnetic interference waves.

Use and maintenance of the product



Do not use the product for any purposes other than dental diagnosis and treatment.

This product is designed for dental diagnosis and treatment.

This product must only be operated by dentists or dental staff performing dental procedures.

Do not use the equipment in an explosive atmosphere (e.g., in the presence of inflammable gases).

Improper use in such an atmosphere may cause injury or fire.

Do not use in the presence of electromagnetic waves.

Do not use equipment generating electromagnetic waves, such as mobile phones, around this product.

Malfunction of this product may occur.



Be sure to turn off the power switch of the product when HF surgical equipment is in use.

Be sure to turn off the power switch when HF surgical equipment is in use because the noise generated from HF surgical equipment may cause incorrect operation of this product.



Never disassemble, repair or modify the product.

Individuals other than your local authorized Belmont dealer should not disassemble or repair this product.

Failure to adhere to this requirement could lead to injury, product failure, electric shock, or fire.

In no case may this product be modified in any way.

WARNING

Installing or transferring the product



Precautions for installation

Product installation must be done by authorized Belmont dealers only.

Make sure to place the product on a firm and flat floor surface. Placing the equipment on a non-flat floor surface may cause it to fall.

Be sure product is plugged into an electrically grounded power outlet (ask a professional to ground the product). Failure or electric leak may result in electric shock.

Ungrounded power connections to the product may result in electric shock.

To avoid the risk of electric shock, this equipment must only be connected to a supply mains with protective earth (ground).

Place no obstacles adjacent to the power outlet which could impede easy access by the power plug.



Do not connect the earth (ground) to the following objects.

Water pipes

(Complete grounding is not possible as hard plastic pipes are widely used.)

Gas pipes

(Can result in an explosion or fire)

Lightning rods and telephone dedicated grounding wire

(Dangerous during lightning)

Power Plug and Cord



WARNING

Do not touch the power plug or power outlet with wet hands.
Failure to do so can result in electric shock.

Use a single power outlet (do not share a power outlet with other plugs).

Use an unshared power outlet with an attached ground terminal. Using the same power outlet together with the power plug of other devices can result in abnormal heat generation and possible fire.

Firmly insert the power plug into the power outlet.

Be sure to fully insert the power plug into the power outlet until reaching the base of the plug.

Failure to fully insert the plug or similar fault can result in a short circuit or heat generation that causes a fire.

Wipe off the dirt on power plug and power outlet with a dry cloth to avoid any possible fire.

Hold by the power plug when unplugging.

Do not pull the cord to remove the power plug from the power outlet. Hold the power plug at the end of the cord when removing. Removing the plug by pulling the power cord can damage the power cord, resulting in electric shock or fire.

Use care when handling the power cord.

Damaging the cord can result in electric shock or fire.

Do not damage the cord.

Do not place objects on top of the cord.

Do not alter the cord.

Do not heat the cord.

Do not excessively bend, twist, or pull the cord.

Do not use damaged cord or plug.

Do not use any power cord or plug that is damaged, or that fits loosely when inserted into a power outlet. Doing so can result in electric shock or fire.

Unplug the power plug when the chair is not in use.

Turn off the power switch and remove the power plug from the power outlet when the chair is not in use. Unexpected operation can result in an accident or fire from a short circuit due to insulation aging.



2 Safety Consideration

Use and maintenance of the product



The patient should clasp his/her hands.



The patient should place his/her feet side by side.

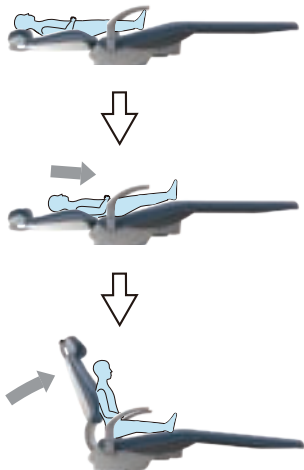

WARNING

Perform cleaning before using the product for the first time. This product is not sterilized or disinfected when shipped.

Do not wash the product with water. This may cause failure or electric shock.

Points to remember when a patient sits on the chair

As shown in the figure on the left, instruct the patient to sit on the chair and make sure his/her body fits on the chair. Ensure that the patient maintains the posture shown in the left figure before operating the chair.

For a young child, the buttocks should be placed on the seat when raising the backrest.

Pay attention to patients and children.

Keep your eyes on the patient when this product is in use. Patients (especially children) may touch the control switch or system inadvertently, leading to an injury or product damage.

Keep children away from this product except when providing treatment.

The patient must not sit on the edge of the seat.

The chair may tip over or move unexpectedly, causing injury or damage to product and peripheral devices.

Use and maintenance of the product



WARNING

Pay close attention to a patients who have a cardiac pacemaker or defibrillator implanted.

If any patient complaint or abnormality is observed, immediately turn off the power switch and discontinue use of the product.

The product may affect the function of the pacemaker or defibrillator, leading to an accident.

Precautions for patient seating and exiting from the product

When the patient gets on or off the chair, the chair should always be at the lowest position and all operations must be locked by the lock switch.

Before moving a patient from a wheelchair to the product or vice versa, ensure that no obstacles (e.g., foot switch) are situated around the wheelchair, the patient or the caregiver.

Obstacles present a potential tripping hazard and may cause injury or damage to peripheral devices.

When the patient is moved from a wheelchair to the product or vice versa, he/she must be carefully assisted or monitored to prevent falling.

If the patient has to get off the product at a position other than the designated position for getting on and off the product due to power failure or in the event of an emergency, he/she must be carefully monitored to prevent falling.

Remove the patient's glasses and any accessories (such as a necklace or bracelets) before treatment.

Failure to follow this instruction may hamper treatment and lead to an accident and injury.

Precautions when raising/lowering the backrest

Before lowering the backrest, ensure that the patient's arm or hand is not sandwiched between the backrest and the seat.

Before raising the backrest, ensure that the patient's arm or hand is not sandwiched between the backrest and the armrest.

Precautions for operating the chair

Before and during the chair operation, pay close attention to the operation range (seat raising/lowering, backrest raising/reclining, and seat rotation), and ensure that the chair does not contact any body parts, hands or feet, or obstacles. Body parts, hands or feet, or objects may become caught in the chair, causing injury.

Before operating the chair, ensure that the patient is seated in the correct position, and keep your eyes on him/her when the chair is in use.

California Proposition 65

Cancer and Reproductive Harm - www.P65Warnings.ca.gov.

Use and maintenance of the product



WARNING

Discontinue use of the product if it is broken or damaged.
In the case of a broken or damaged product, immediately discontinue use and turn off the power switch. Then, contact your local authorized Belmont dealer to repair the product.

Precautions during seat rotation

Make sure that no persons or objects are nearby before slowly rotating the seat.

Be careful of the patient when the backrest is reclined and check that the safety of the patient is ensured before rotating the chair.

After rotating the seat, be sure that the seat safely locks into position.

Always be sure that rotation is locked before operating the product. Accidental rotation of the product can result in injuries or damage to nearby equipment or cabinetry in the treatment room.

Prohibition of using this equipment adjacent to or stacked with other electronic equipment

Use of this equipment adjacent to or stacked with other equipment should be avoided because it could result in improper operation. If such use is necessary, this equipment and the other equipment should be observed to verify that they are operating normally.

Prohibition of placing portable RF communications equipment adjacent to this product

Portable RF communications equipment (including peripherals such as antenna cables and external antennas) should be used no closer than 30 cm (12 inches) to any part of Evogue Chair (Model Q3300), including cables specified by the manufacturer. Otherwise, degradation of the performance of this equipment could result.

Turn off the power switch and unplug the power plug before cleaning.

Failure to do so can result in injury, electric shock or fire.

Clean the product thoroughly.

Poor cleaning may cause bacteria to grow, posing a health risk. See cleaning procedures on pages 32 to 33.

Be sure to conduct routine maintenance.

Use of the product without routine maintenance may cause injury or damage to the product.

See maintenance information on pages 34 to 35.

Procedures if a power outage occurs

Turn off the power switch. Remove the power plug of the product from the power outlet to prevent unexpected operation when power is restored.

CAUTION

Use and maintenance
of the product



Do not allow a person who exceeds 440lbs (200kg) to sit on the chair.

Injury or product failure may occur.

Do not hit or rub against the product.

This may cause damage to the covers or operational failure.

Ensure that each part operates normally, with no abnormalities detected, each time before product operation.

Always inspect the product for abnormal findings such as loose components, backlash, tilting, vibration, sound, abnormal temperature, or bad odors.

If you feel something is wrong, immediately discontinue use of the product and turn off the power switch. Contact your local authorized Belmont dealer for service.

Read the accompanying documents for this product.

Before use, make sure to carefully read the instructions for use supplied with this product and use the device correctly.

Be sure to operate switches manually.

Make sure to operate the switches manually, except for the foot switch operated by the foot. Failure to operate the switches by hand may cause damage or malfunction.

Carefully operate the switches.

The operator should pay close attention to people on and around the product before operating switches.

Precautions when using the headrest

During headrest positioning, ensure that fingers do not become caught or sandwiched between the headrest mechanism parts and the backrest.

Use caution to prevent tripping over the power cord.

Failure to do so can result in injury.

Immediately wipe off any drug solutions or water spills onto the product.

Drug solutions or water spilled onto product control surfaces may lead to operational failure, electrical shorts or potential injury. If drug solutions or water are visible on product surfaces, immediately turn off the power switch and wipe surfaces with a dry, soft cloth.

Precautions for cleaning procedures

The metal parts and mechanical parts of the chair may have sharp edges. Be careful when cleaning the chair that your hands, fingers or other body parts are not injured.

Turn off the power switch at the end of each day or during a break.

Turning off power supply protects the product from potential damage and users from potential injury.

Important points to remember when operating the product

Meaning of a symbol



Point to remember

(locations requiring attention including moving parts, rotating parts, and detachable parts)

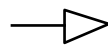

Point to remember where an emergency stop mechanism is available

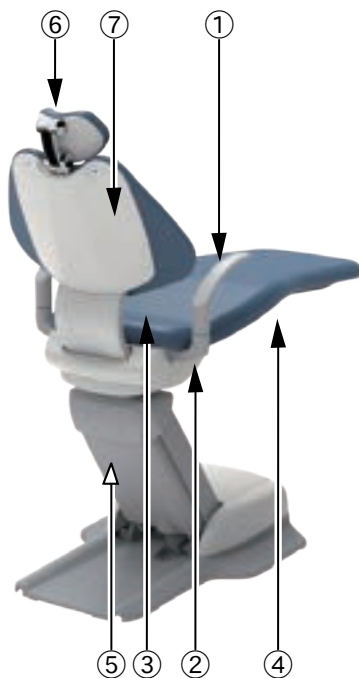

Meanings of each point to remember

- ① Take care to prevent body parts or objects from becoming caught in the armrest (when rotating).
Do not operate the chair when the armrest is rotated outward.
- ② Take care to prevent body parts or objects from becoming caught in the armrest (when lowering the chair).
Do not place the body parts or objects at the armrest bracket when lowering the chair.
- ③ Take care to prevent body parts or objects from becoming caught in the backrest moving parts.
Do not sandwich your hands or feet between the backrest and the seat.
- ④ Take care to prevent body parts or objects from becoming caught underneath the bottom of the seat.
Do not place your hands or feet in the bottom of the seat.
- ⑤ Take care to prevent body parts or objects from becoming caught underneath the rear link cover.
Do not place the body parts or objects between the rear link cover and base plate.
- ⑥ Take care to prevent body parts or objects from becoming caught in the headrest moving parts.
Ensure that your fingers and hair do not become caught in the headrest moving part.
- ⑦ Take care when raising or reclining the backrest to prevent contact with cabinetry surfaces and nearby equipment.
Before operating the backrest, ensure that no obstacles are placed around the backrest.

2-3 EMC Information

This product complies with EMC Standard IEC60601-1-2:2014.

1. Precautions regarding EMC and compliance with accompanying documents

Medical electrical equipment requires special precautions regarding EMC and needs to be installed and put into service according to the EMC information provided in this booklet.

2. Effects of RF communication devices

Portable and mobile RF communication devices can affect medical electrical equipment.

3. Installation exclusion environment

Hospitals except for near active HF SURGICAL EQUIPMENT and the RF shielded room of an ME SYSTEM for magnetic resonance imaging, where the intensity of EM DISTURBANCES is high.

4. Electromagnetic emission declaration

Guidance and manufacturer's declaration—electromagnetic emissions		
Evogue Chair (Model Q3300) is intended for use in the electromagnetic environment specified below. The customer or user of Evogue Chair (Model Q3300) should ensure that it is used in such an environment.		
Emissions test	Compliance	Electromagnetic environment—guidance
RF emissions CISPR 11	Group 1	Evogue Chair (Model Q3300) only uses RF energy for its internal functions. Therefore, its RF emissions are very low and are not likely to cause any interference with nearby electronic equipment.
RF emissions CISPR 11	Class B	Evogue Chair (Model Q3300) is suitable for use in all establishments, including domestic establishments and those directly connected to the public low-voltage power supply network that supplies buildings used for domestic purposes.
Harmonic current emissions IEC 61000-3-2	Not applicable	
Voltage fluctuations/ Flicker emissions IEC 61000-3-3	Not applicable	



WARNING

Use of this equipment adjacent to or stacked with other equipment should be avoided because it could result in improper operation. If such use is necessary, this equipment and the other equipment should be observed to verify that they are operating normally.

5. Electromagnetic immunity declaration 1

Guidance and manufacturer's declaration—electromagnetic immunity			
Evogue Chair (Model Q3300) is intended for use in the electromagnetic environment specified below. The customer or user of Evogue Chair (Model Q3300) should ensure that it is used in such an environment.			
Immunity test	IEC 60601 test level	Compliance level	Electromagnetic environment—guidance
Electrostatic discharge (ESD) IEC 61000-4-2	±8 kV contact ±15 kV air	±8 kV contact ±15 kV air	Flooring should be wood, concrete, or ceramic tiles. If the floor is covered with synthetic material, the relative humidity should be at least 30%.
Electrical fast transient/burst IEC 61000-4-4	±2 kV for power supply lines ±1 kV for input/output lines	±2 kV for power supply lines ±1 kV for input/output lines	The mains power quality should be that of a typical commercial or hospital environment.
Surge IEC 61000-4-5	±1kV differential mode ±2kV common mode	±1kV differential mode ±2kV common mode	The mains power quality should be that of a typical commercial or hospital environment.
Voltage dips, short interruptions and voltage variations on power supply input lines IEC 61000-4-11	0% UT ; 0.5 cycles 0°,45°,90°,135°,180°, 225°, 270° and 315° 0% UT ; 1cycle and 70% UT ; 25/30 cycles at 0°, single phase 0%UT ; 250/300 cycles	0% UT ; 0.5 cycles 0°,45°,90°,135°,180°, 225°, 270° and 315° 0% UT ; 1cycle and 70% UT ; 25/30 cycles at 0°, single phase 0%UT ; 250/300 cycles	The mains power quality should be that of a typical commercial or hospital environment. If the user of Evogue Chair (Model Q3300) requires continued operation during mains power interruptions, it is recommended that Evogue Chair (Model Q3300) be powered from an uninterruptible power supply or a battery.
Power frequency (50/60 Hz) magnetic field IEC 61000-4-8	30A/m	30A/m	Power frequency magnetic fields should be at levels characteristic of a typical location in a typical commercial or hospital environment.
Note UT is the AC mains voltage prior to the application of the test level.			

6. Electromagnetic immunity declaration 2

Guidance and manufacturer's declaration—electromagnetic immunity			
Evogue Chair (Model Q3300) is intended for use in the electromagnetic environment specified below. The customer or user of Evogue Chair (Model Q3300) should ensure that it is used in such an environment.			
Immunity test	IEC 60601 test level	Compliance level	Electromagnetic environment—guidance
Conducted RF IEC 61000-4-6	3V 0.15MHz-80MHz 6V 0.15MHz-80MHz in ISM bands and amateur radio bands	3V 0.15MHz-80MHz 6V 0.15MHz-80MHz in ISM bands and amateur radio bands	Warning: Portable RF communications equipment (including peripherals such as antenna cables and external antennas) should be used no closer than 30 cm (12 inches) to any part of Evogue Chair (Model Q3300),including cables specified by the manufacturer. Otherwise,degradation of the performance of this equipment could result.
Radiated RF IEC 61000-4-3	3V/m 80MHz-2.7GHz 80% AM (1 kHz)	3V/m 80MHz-2.7GHz 80% AM (1 kHz)	
Near electromagnetic field caused by RF wireless communication devices IEC61000-4-3	See the table on the next page (page 20)	See the table on the next page (page 20)	

7. Essential performance

Unless operated by the chair control switch, the chair will not make any movements except for sounding a buzzer and switching the indicator on/off.

Loss or decline of essential performance may cause the chair to move unexpectedly, causing harm or damage to the patient, the operator or people or objects around the patient or the operator.



Portable RF communications equipment (including peripherals such as antenna cables and external antennas) should be used no closer than 30 cm(12 inches) to any part of this product, including cables specified by the manufacturer.

Otherwise,degradation of the performance of this equipment could result.

Near electromagnetic field caused by RF wireless communication devices

Test frequency (MHz)	Modulation	IEC 60601 test level	IEC 60601 compliance level
385	Pulse modulation ^{a)} 18Hz	27V/m	27V/m
450	Frequency modulation ±5kHz shift 1kHz sine wave	28V/m	28V/m
710 745 780	Pulse modulation ^{a)} 217Hz	9V/m	9V/m
810 870 930	Pulse modulation ^{a)} 18Hz	28V/m	28V/m
1720 1845 1970	Pulse modulation ^{a)} 217Hz	28V/m	28V/m
2450	Pulse modulation ^{a)} 217Hz	28V/m	28V/m
5240 5500 5785	Pulse modulation ^{a)} 217Hz	9V/m	9V/m
Note a) The carrier is modulated by a square wave with a 50% duty cycle.			

3-1 Operating Precautions

Immediately wipe off any drug solutions spilled onto the product.

Otherwise, they may cause deterioration or discoloration.

Do not apply heat to the product.

This may cause deterioration or discoloration.

Discoloration of plastic materials.

Plastic materials are used in external components of the product. Carefully selected materials are used; however, discoloration may occur for reasons such as natural deterioration or the spilling of drug solutions.

To ensure use of the product for as long as possible, immediately wipe off any drug solutions spilled and avoid sunlight.

Other than patients, do not place objects on the seat.

This may cause deformation, tears, or corrosion of the leather.

Patient weight limit [440 lbs (200 kg)].

The seat may rise slowly if a person weighs close to the chair lift capacity limit.

3-2 Precautions for Upholstery

Adherence of clothing dye

Dye may migrate from clothes or belts to the upholstery of the product. If dye migrates to upholstery surfaces, wipe gently with a soft cloth moistened with a neutral detergent which has been diluted to about one-tenth with water as soon as possible to prevent penetration into upholstery material. Next, wipe detergent residue away with a soft cloth that is moistened with clean water. Use another soft cloth to dry surfaces.

Prevent deterioration and dye migration to product surfaces.

Contact with plastic materials, coated products, solvents, and adhesive tapes may cause changes in the surface gloss, cracks, deformation or abrasion.

Dye may migrate from newspapers or printed matter to the product.

Dye may migrate from printed clothes such as T-shirts or denim clothes to the upholstery of this product.

Adherence of benzene, nail polish remover, alcohol, or oil to product surfaces may cause discoloration, surface dissolution, changes in gloss, hardening, softening or abrasion.

Use of bleach may cause deterioration of product.

Placing the product near a heat source such as a heater may cause deformation or discoloration of product surfaces.

Shield the product from direct sunlight by using a curtain. Direct sunlight may cause surface change, shrinkage, discoloration or fading.

Do not place objects on the product because they may damage the upholstery.

4 Product Specifications

4-1 Technical Data

Model	AC-Q33-CD36*
Classification for protection against electric shock	Class I Equipment
Classification according to the degree of protection against electric shock	Type B Applied Parts(chair upholstered parts / armrest)
Rated voltage	AC120 V
Power frequency	60 Hz
Power input	4.2 A
Fuse	Fuse holder 10A / 250V (Interrupting capacity: 750A / 250VAC) Operating speed: Interrupting Size: 6.3 × 32 mm Chair control board 1.25A / 250V (Interrupting capacity: 1500A / 250VAC) Operating speed: Interrupting Size: 5.2 × 20 mm
Operation mode	Non-continuous operation (motor) Maximum operating time, 3 minutes DUTY 1:15
Weight	293 lbs (133 kg)
Chair Initial height/stroke	15.7 / 15.7 inch (400 / 400 mm)
Chair raising and lowering mechanism	Electrohydraulic
Headrest	Manual
Backrest	Electrohydraulic
Seat	Backrest-linked tilt mechanism
Armrest	With rotation function on both sides
Upholstered parts	Synthetic leather
Operation switch	Backrest switch/Foot switch
Usage environment	Temperature 32 ~ 104°F (0 ~ 40°C) Humidity 10 ~ 95% (No condensation) Atmospheric pressure 10 ~ 15.4 psi (700 ~ 1060 hPa)
Patient weight limit	440 lbs (200 kg)
Use in high-oxygen environments	The product is not suitable for use in a high-oxygen environment.

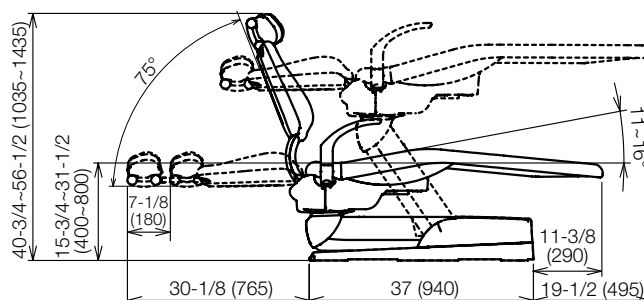
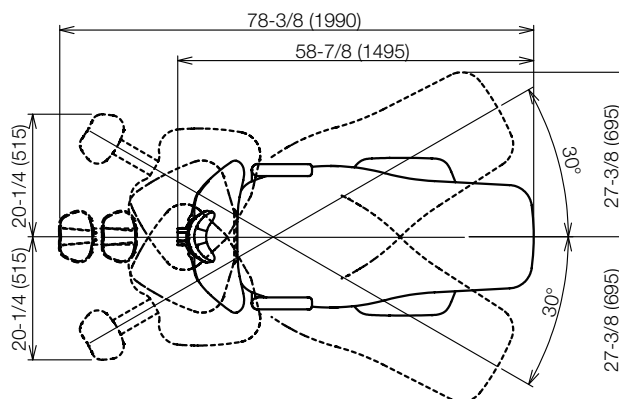
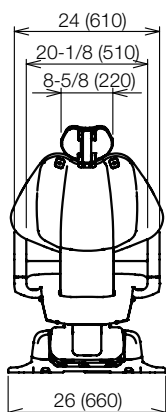





Unit : inch (mm)
Tolerance in dimensions: ±10%

The specification is subject to change without notice.

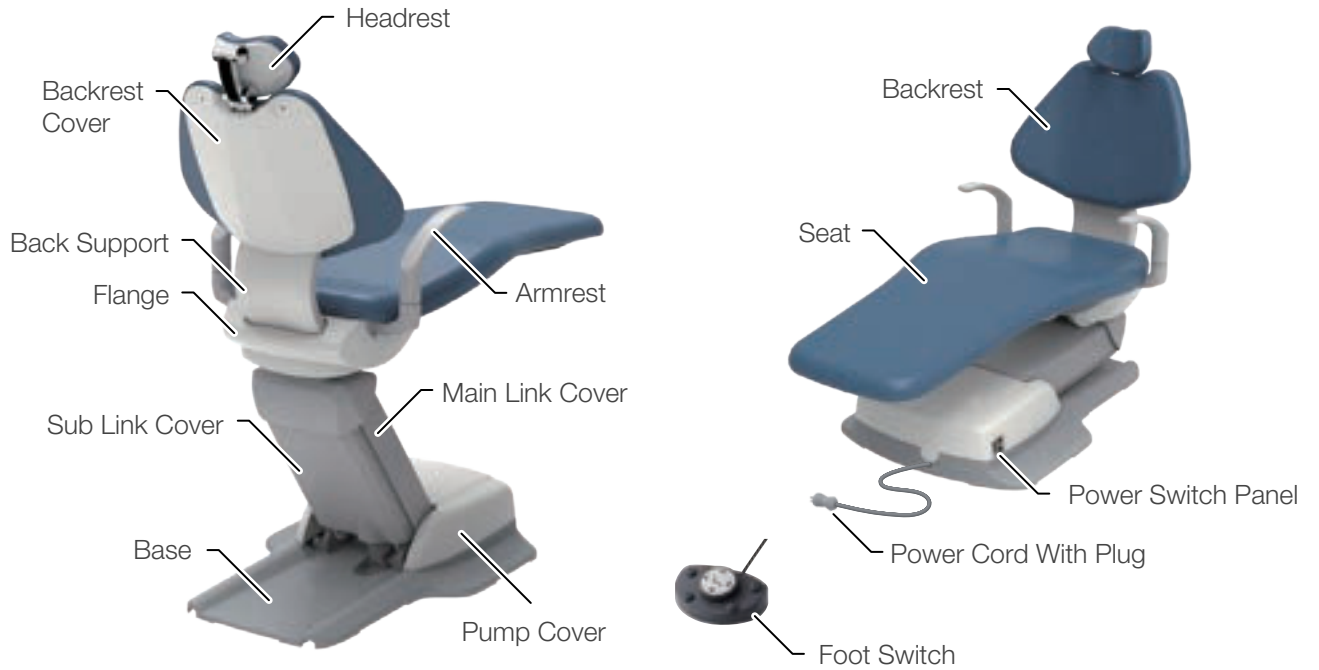
4 Product Specifications

4-2 Name of Each Part

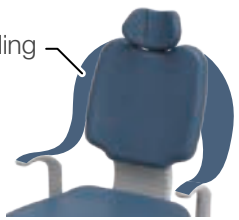

	Specifications	
Backrest Styles	<p>Wide Back Style</p> 	<p>Narrow Back Style With Slings</p> <p>Sling</p> 
Swivel Lock Release switches (Backrest cover)	<p>Swivel Lock Release Switches</p> 	
Foot switch	<p>Switch for manual operation</p> <p>① Preset switch 1</p> <p>② Preset switch 2</p> <p>ⓐ Automatic return switch</p> <p>ⓑ Preset switch 3</p> 	

5-1 Preparation Before Use

1. Inserting the power plug into the power outlet

Fully insert the power plug into a grounded power outlet. (AC120V)

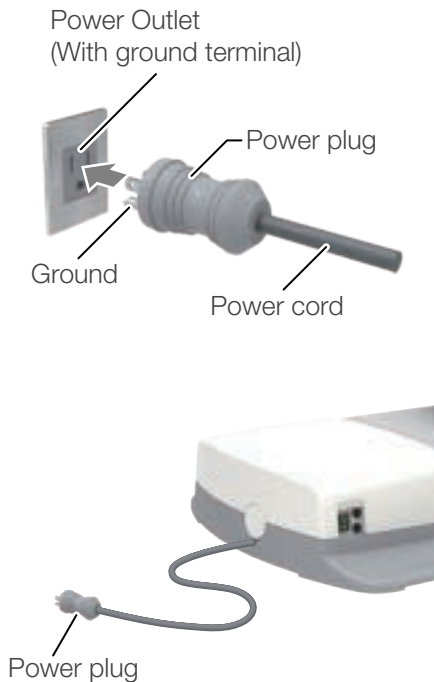

WARNING

Connect power plug directly to a grounded power outlet.

Be sure to fully insert the power plug into the power outlet.

Use a dry cloth to wipe any dirt from the power plug and power outlet to reduce the potential for fires.

Do not pull the power cord to remove the power plug from the power outlet. Hold by the power plug at the end of the cord when removing it from the power outlet.

Protect the power cord from damage.

Do not damage the cord.

Do not place objects on top of the cord.

Do not alter the cord.

Do not heat the cord.

Do not excessively bend, twist, or pull the cord.

Do not use the product if the power cord or plug is damaged, or if the power plug fits loosely when inserted into an power outlet.

Do not touch a power plug or power outlet with wet hands.

Do not connect the earth (ground) to the following objects.

Water or gas pipes, lightning rods and telephone dedicated grounding wire

Consult an electrician for grounding procedures to ensure secure ground connections.

Turn off the power switch and remove the power plug from the power outlet when the chair is not in use.

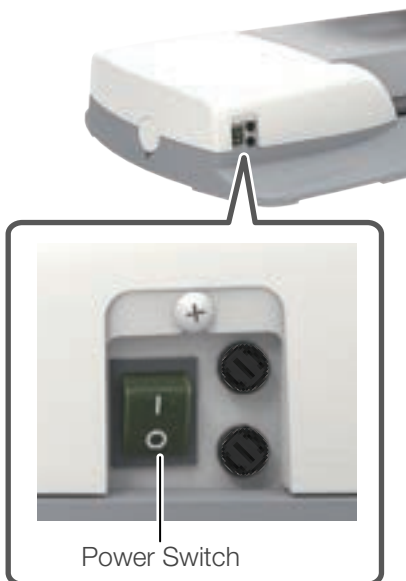

2. Turn on the power

Press the upper side (I) of the power switch.
A green lamp inside of the power switch will illuminate.

CAUTION

Operate the power switch by hand.

Turn off the power switch whenever the chair is not in use. This important safety measure will protect the product from potential damage and staff from potential injury.

When the power is turned on, seat swivel is locked within one second.

5-2 Operating the switches

Operate the chair by using the built-in backrest cover switches or foot switch.

The overview of switch functions is as follows:



Seat Swivel Lock Release Switch

Press  before manually swiveling the seat.

After  is pressed, the lock of swivel will be released for duration of 10 seconds.

Seat may be rotated 30 degrees to the right or left of center.

Pressing  again during the 10 seconds duration will automatically lock seat into position.



Foot switch

Switch for manual operation

Manual operation of the seat raising/lowering and backrest raising/reclining.

Step on  to raise the seat.

Step on  to lower the seat.

Step on  to recline the backrest.

Step on  to raise the backrest.



Automatic return switch

The seat will move to entry/exit position.



Preset switch

The chair will move to treatment 1 position when this switch is stepped on.



The chair will move to treatment 2 position when this switch is stepped on.



The chair will move to treatment 3 position when this switch is stepped on.

Do not step on and hold the preset switch, automatic return switch for more than five seconds. If these switches are pressed and held for more than five seconds, a buzzer sound will be heard, and the chair position will be programmed into memory as the preset position for the switch.



WARNING

Before operating the chair, ensure that the patient is sitting in the correct position, and keep your eyes on him/her when the chair is in use. (refer to page 12)

Before operating the chair, confirm that no human body part, limb is in danger, or any object is obstructing the operation of the chair.





Cancellation function

To stop automatic operations, press the swivel lock release switch on the backrest cover, or step on any foot switch function.

An electronic beep sounds when the operation is cancelled.

Setting for automatic operation

You can alter the default of the Treatment Position and/or Entry/Exit Position

1. Set the seat and the backrest to the desired treatment position or entry/exit position by foot switch.
2. Step on and hold the desired switch until buzzer sounds (for more than 5 seconds) then release it. The position becomes set in memory.
 - Set to treatment 1 position: Step on 
 - Set to treatment 2 position: Step on 
 - Set to treatment 3 position: Step on 
 - Set to entry/exit position : Step on 
3. After manually moving the chair to a different position, press the switch you have just set to confirm that the seat moves to the newly memorized position.

5-3 Rotating the Seat



1. Press swivel lock release switch 
2. Hold the backrest or armrests when rotating the seat.
Rotate the seat until it reaches the desired position.

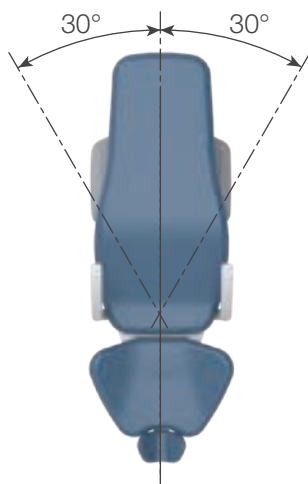

Rotation range: 60°
(With the base facing forward, 30° to the right and 30° to the left)

WARNING

When the patient sits on or gets out of the seat, be sure to put the product in the entry/exit position (seat is lowered to the bottom, the backrest is raised, and the rotating mechanism is locked).

Be careful of the following when rotating the seat in order to ensure safety.

Lower the seat to the lowest position.

Check that the patient is seated in the proper posture and position.

Be sure that there are no other persons or things in the surrounding area, and ensure that the product does not contact the patient or any nearby equipment.

Be sure to always lock (secure) the seat swivel after seat rotation.

5-4 Adjusting the headrest position

Adjustment of the headrest

The headrest has a double-articulating mechanism, which permits the patient's head to be tilted forward and backward for access to the upper/lower jaw.

It is also possible to extend/retract the sliding headrest bar in accordance with the patient's height.

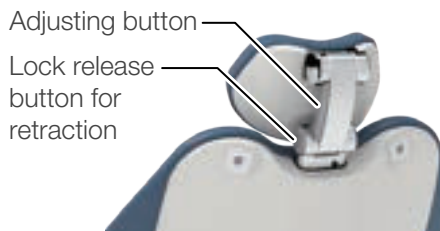

Angle adjustment of the headrest

1. Place the operator's hand beneath the headrest to support the patient's head.
2. Depress the adjusting button with the other hand to release the headrest position lock for adjustment of headrest.
3. Adjust the headrest angle to the desired one for treatment. Release the adjusting button to lock the headrest position.

Operating range of the headrest

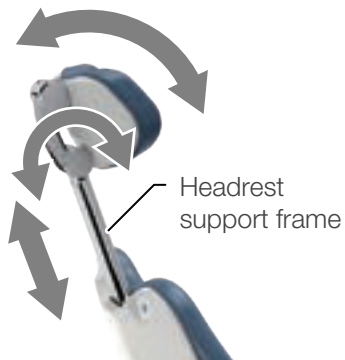

Up/down adjustment of the headrest

1. To raise the headrest, pull the headrest up slowly .
2. To lower the headrest, push it down slowly while depressing the lock release button for retraction.

Do not apply excessive load or impact to the headrest while it is extended. Do not hit the headrest from above. Do not sit on the headrest. Otherwise, failure may result.

WARNING

If the backrest is to be moved while the headrest is extended, confirm that there is no object which may come into contact with the chair. Product damage or injury may result if headrest or backrest contacts equipment or cabinetry.

When operating the headrest, be careful not to get hands or fingers caught in the headrest mechanism, or between the headrest and backrest.

When adjusting the headrest angle or headrest height, be sure to support the patient's head before making all adjustments, otherwise, an accident or injury may result.

Be sure that the headrest is not rattling or making abnormal noise. Moving the headrest while rattling may result in an accident or injury.

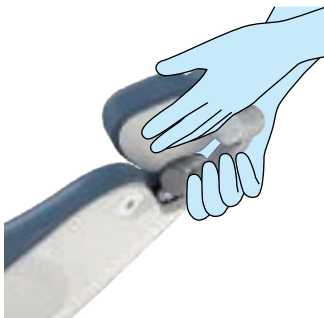

5-5 Rotating the armrests for patient entry/exit

If the armrest hinders entry/exit or treatment, it may be rotated outward and backward.

Both the left and right armrests can be rotated outward and backward.



(1) Pull the base of the armrest upward.



(2) Rotate the armrest backward while holding it up.
Armrest rotation angle: 130 degrees



(3) To return the armrest to the original position, turn it forward using the same procedure.
The armrest is locked when it is rotated to the forward position parallel to the seat

CAUTION

When turning the armrest, confirm that there is no obstruction.
Operator must be careful not to get their hands or fingers caught.

Do not move the seat while the armrest has been rotated backward.
Return the armrest to the forward position before moving the seat.

Excessive load must not be applied to the armrest.
Do not sit on the armrest.
This may cause injury due to falling, or damage to peripheral devices.

5-6 Safety Switch function

If any object comes into contact with the rear link cover during operation, the safety switch function will automatically stop all motion, and the chair will rise for approx. 1 second.

Remove the obstacle that has caused emergency stop, confirm safety, and resume operation of the chair.



6-1 Cleaning and disinfection

Clean this chair before and after use to maintain it in a clean state.

WARNING

Turn off the power switch and unplug the power plug before cleaning. Failure to do so can result in electric shock or fire. This step will also prevent sudden movement of the chair while cleaning, which can result in injury.

Do not wash with water. This may cause failure or electric shock.

Poor cleaning may cause bacteria to grow, posing a health risk.

CAUTION

The metal parts and mechanical parts of the chair may have sharp edges. Exercise care to prevent injury to hands, fingers or other body parts when cleaning chair.

Upholstery and Plastic Parts

Wipe surfaces gently with a dry soft cloth.

For extremely dirty surfaces:

Wipe off any stains or dirt with a soft cloth that has been moistened with a neutral detergent diluted with water to approximately 10%. Afterward, wipe surface with a damp cloth to remove detergent, then thoroughly wipe it dry.

Parts touched by the patient:

Use a soft cloth saturated with disinfectant to clean the cushion parts, such as the headrest, backrest, seat, and armrest, as well as the other parts possibly touched by the patient.

As an example of disinfectant solutions for cleaning, use OPTIM33TB manufactured by SciCan.

Control Panels and Metal Parts

Wipe surfaces clean using a dry soft cloth.

Do not clean these parts with a wet cloth because they are adversely affected by moisture and water. Wipe off all moisture immediately if any water gets on these parts. Water left on these parts will result in rust or malfunction of electronic parts.



6 Maintenance and Cleaning

Never use any of the products listed below:

Volatile chemicals such as paint thinner, butanol, isopropyl alcohol, nail-polish remover, gasoline, or kerosene; acid, alkaline or chlorine detergents; highly corrosive disinfectants (povidone-iodine such as Iodine, sodium hypochlorite, etc.); abrasive polishing wax or abrasive sponge

Do not use a brush or scrubber for maintenance. All of these may leave scratches and/or ingrained dirt.

If water or detergent is left on the surface, wipe it off immediately. Moisture or detergent may cause rust or failure of electrical parts.

Do not spray detergent directly onto product surfaces.

Clean the surface with a soft cloth or paper towel moistened with detergent, then wipe it dry with a cloth.

If liquid enters the product, it may cause a malfunction, failure or injury.

Confirm that the product surfaces are completely dry before operating the product.

Clean chairs that have not been used for an extended period of time before using them again. After cleaning, be sure to always check that the chair operates properly.

6 Maintenance and Cleaning

6-2 Maintenance and inspection

Notes on daily maintenance and inspection (by the user)

Management of maintenance and inspection of dental/medical equipment should be implemented by the user (dental/medical institution).

For safe use of the product, it is necessary that inspection should be conducted in the specified frequency on the items described below.

If the chair does not work normally, immediately stop using the chair, turn off the power, unplug the power plug, and contact your local authorized Belmont dealer.

No.	Item	Frequency	Inspection method and diagnosis	Influence if inspection not conducted	Maintenance required in case of nonconformity
1	Confirmation of the cancel function for auto operation	Before start	Operation should stop when any switch is pressed during automatic operation.	Unexpected personal injury and troubles may arise due to motion of the chair during medical treatment and due to pinching between doctor section and chair.	Contact your local authorized Belmont dealer if any abnormality arises.
2	Power supply cable	Before start	Power supply cable should not be abnormally bent, pinched or damaged, and the plug should be firmly inserted to the power outlet and not covered with dust.	The product does not function properly, which may cause electrical shock or a fire.	Clean and rearrange the cable. For replacement, contact your local authorized Belmont dealer.
3	Function of each switch	Before start	Each switch for chair operation should work correctly.	The product does not function properly, impeding proper treatment or procedure.	Contact your local authorized Belmont dealer if any abnormality arises.
4	Moving parts	Before start	Make sure that the chair does not make any abnormal noise during automatic and manual movement.	The product does not function properly, impeding proper treatment or procedure.	Contact your local authorized Belmont dealer if any abnormality arises.
5	Oil leakage	Before start	Make sure that there is no hydraulic oil on the floor or chair base leaking from the cylinder.	The product does not function properly, impeding proper treatment or procedure.	Contact your local authorized Belmont dealer if any abnormality arises.
6	Stain removal of external parts	After closing	Visually inspect product surfaces for presence of, dust, chemicals or other contamination and evaluate overall product cleanliness.	Discoloration, transformation or breakage of resin parts may arise.	Clean up according to the "Cleaning Procedures" in this instructions for use.

WARNING

Always refer to this Guide before conducting daily maintenance and inspection.

If you do not conduct daily maintenance or inspection, use of the product may result in injury or damage to nearby devices and potential product damage.

Notes for periodic inspection

This product contains parts that may stop functioning or wear out depending on frequency of use, and therefore it is important to carry out maintenance and periodic inspection once a year (including replacement of consumables) and safety checks.

Service parts required for the periodic inspection (including consumables) are listed in the table below. Depending on the specifications of your device, there may be alternative parts available that differ from those listed in the table below.

Maintenance and inspection can be outsourced to qualified persons such as authorized dealers that are qualified to repair dental/medical devices. If you have any questions about periodic inspection, contact your local authorized Belmont dealer.

List of service parts required for the periodic inspection

Part name	Standard Lifetime	Part name	Standard Lifetime
Headrest moving parts	2 years	Armrest moving parts	5 years
Electric wiring of moving parts	5 years	Hydraulic moving part (O-ring, Packing)	5 years
Switches	5 years		
Backrest moving parts	5 years	Solenoid Valve	7 years

List of consumables required for the periodic inspection

Part name	Part name
O-ring	Packing

WARNING

Always entrust periodic inspection to your local authorized Belmont dealer.

If you do not carry out periodic inspection, use of the product may cause injury or damage to product or nearby devices.

6-3 Environmental Conditions for Transportation or Storage in Packaging

(1) Environmental conditions for the transportation or storage in packaging of the product shall be as specified below.

Temperature -4 ~ 158°F (-20 ~ 70°C)

Humidity 10 ~ 95% (No condensation)

Air pressure 10 ~ 15.4 psi (700 ~ 1060 hPa)

(2) Pay attention to the following items for the storage area.

Store the equipment in places where water is not present.

Store the equipment in places where there are no adverse environmental conditions outside of the stated ranges of atmospheric pressure, temperature; as well as excessive humidity, poor ventilation, direct sunlight, dust, and corrosive air containing salt or sulfur.

Pay careful attention to keep the equipment upright and stable, avoiding tilting, vibration, and shock (including those during transport).

Do not store the equipment in places where chemicals are stored or gases are generated.

6-4 Storage method

If the product is not used for an extended period of time, after practice hours of operation or during holidays, be sure to observe the precautions below:

1. Make sure to disconnect the power supply plug from the electrical outlet. (This is to prevent the supply of electric power.)
Make it a habit to do this to prevent electrical accidents.
2. Set the chair to the lowest position and the backrest to the most reclined position.

7-1 Troubleshooting

If you encounter any of the problems listed below, take the countermeasures described below before requesting a repair from an authorized Belmont dealer. If the problem persists even after troubleshooting, stop using the product immediately, turn off the power switch, and contact your local authorized Belmont dealer.

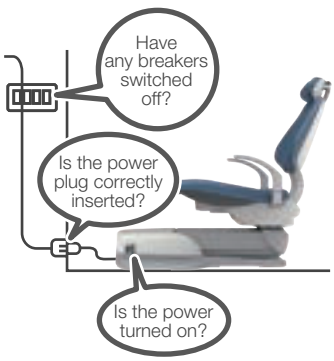
Problem	Check Points	Solutions
<p>The product does not work at all.</p> 	Is the power plug fully inserted to the power outlet?	Fully insert the power plug into the power outlet until reaching the base of the plug. (page 24)
	Is the power switch on?	Turn on the power switch. (page 25)
	Have any power service circuit breakers switched off or fuses blown ?	Switch breaker to the ON position or replace blown fuse.
	Has the chair been operated for an extended period continuously?	<p>The problem is due to excessive operation and overheating of the product. ⇒Leave the chair for approximately 10 min. to allow it to cool down and return to the normal condition.</p> <p>Overheating Prevention Device This product includes a protective circuit that prevents abnormal overheating of internal mechanisms due to continuous operation. Product may need to cool down temporarily before being restored to use.</p>
Seat motion unexpectedly stops.	Is there an object in contact with the rear link cover and triggering the safety switch function?	Remove the object to restore seat motion function to the chair. (page 31)

These are not malfunctions	
Sound at startup	This sound is typically due to the internal hydraulic fluid being cold. It is not a functional fault and the sound should stop shortly thereafter.
Slow movement of the seat	Slow movement is due to the internal hydraulic fluid being cold. Raise the room temperature or continue operating seat motion functions for a short period of time. Product motion will recover to the normal condition after the oil temperature rises.
Sound when rotating the seat	This is the sound of the steel ball bearings rolling when the seat is rotated. The level of this sound varies, depending on the environment where the chair is installed.

8-1 After-sales service

Before requesting a service visit from authorized dealers for product repair

Refer to 'Troubleshooting' [from page 37 on] and check the product. If the problem persists, turn off the power switch, and contact your local authorized Belmont dealer to request a repair.

8-2 Service life

The service life of this product is 10 years, on condition that maintenance and inspection are properly conducted [according to our self-certification (our data)].

The standard lifetime of service parts that require periodic inspection varies according to the part. [page 35]

8-3 Period of Parts Retention

Service parts for this product will be offered for a period of 10 years from the time of purchase.

* Service parts are parts required to repair products in order to restore or maintain functionality to the product.

9-1 Accessories

Instructions for Use (this document)
Installation Instructions

9-2 Consumables

Consumables are parts that will normally wear or deteriorate, change their appearance, or become damaged with use. Please note that repair or replacement of consumables are not covered by the warranty and will be available for purchase.

(* Degree of wear, deterioration or damage and timing for replacement depends on product usage, environment and conditions at the customer's premises.)

Consumable parts are out of the warranty coverage, and to be charged.

[Reference] List of consumables required for the periodic inspection [page 35]

Also, the exterior parts (metal parts, plastic parts, etc.) are not covered by the chair warranty in cases of exterior damage, dirt, deterioration, color fading, or similar problems. Upholstery is covered by a separate warranty



Importer in U.S.A.

BELMONT EQUIPMENT,

Division of Takara Belmont USA, Inc.

101 Belmont Drive, Somerset, New Jersey 08873 U.S.A.

TEL.: (732) 469-5000 / (800) 223-1192

FAX.: (732) 356-1035

Importer in Canada

TAKARA COMPANY, CANADA, LTD.

2455 Meadowvale Blvd. Mississauga, Ontario L5N 5S2, Canada

TEL : (905) 816-8965

www.belmont.ca

BELMONT MANUFACTURING CO., LTD.

(Manufacturer)

Lot I-2, Long Duc Industrial Park, Long Duc Ward,

Long Thanh District, Dong Nai Province, Vietnam

TEL.: +84-2513-201-100 / FAX.: +84-2513-201-096

