

Quolis[®] Series

Quolis 5000 Dental Unit

OPERATING INSTRUCTIONS

IMPORTANT

This manual provides operating instructions for the Quolis 5000 unit. The instructions contained in this booklet should be thoroughly read and understood before operating the unit and chair. After the installation has been completed, keep this manual in a safe place and refer to it for future maintenance.



Intended Use of the Product

This product is an active therapeutic device intended to administer or exchange energy of electric, air and water for the exclusive use for diagnoses, treatments and relative procedures of dentistry, and its characteristic is not in a potentially hazardous way between such energy and human body, taking account of the nature, the density and site of application of the energy.

The product must be operated or handled by the qualified dentists or by dental staffs under the supervision of the dentist.

Such dentists or dental staffs should instruct and/or assist the patients to approach to and leave from the product.

Patients should not be allowed to operate or handle the product unless he/she is so instructed.

The product is supplied together with the handpieces like electric micromotor, air turbine and/or motor, scaler and so on.

Environmental Requirments

Ambient Temperature Operating 41°F to 104°F Storage 14°F to 122°F

Humidity 10 % - 80%

Atmospheric Pressure 8.7psi – 15.4psi

Compatibility of Handpieces

Use the compatible handpieces as shown in the section 9. List of compatible handpieces.

Classification of Equipment

- a. Type of shock protection : Class I Equipment
- b. Degree of shock protection : Type B Applied part 
- c. Degree of protection against water ingress : Ordinary Equipment (All Products)
- d. Mode of operation : Continuous Operation
- e. Flammable Gasses : Not suitable for use in the presence of a flammable anesthetic mixture with air, oxygen, or nitrous oxide.
- f. Earth : Protective earth (ground)
- g. Hospital Grade Plug : Grounding reliability can be achieved only when the equipment is connected to an equivalent ground receptacle marked hospital only or hospital grade.

TABLE OF CONTENTS

	Page
1. Overall view and major components -----	1
1-1. Delivery system with Vac Pac & Light-----	1
1-2. Delivery system with Cuspidor Section & Light-----	2
2. Dimensions and specifications -----	3
2-1. Delivery system with Vac Pac & Light-----	3
2-2. Delivery system with Cuspidor Section & Light-----	2
3. Operating Instructions -----	5
3-1. Doctor Table Sections -----	5
3-2. Vac Pac Section -----	16
3-3. Delivery system with Cuspidor Section-----	17
3-4. Foot Control Section -----	20
4. Right / Left Handed Dentistry Conversion -----	21
5. Care and Maintenance -----	22
6. Unit Flow Diagram	
6-1. Doctor Table Section -----	23
6-2. Swing Arm Section -----	24
6-3. Vac Pac Section -----	24
6-4. Cuspidor Section -----	25
6-5. Junction Box Section -----	26
6-6. Overall Unit Flow Diagram (Delivery system with Vac Pac) -----	27
6-7. Overall Unit Flow Diagram (Delivery system with Cuspidor section) -----	27
7. Location of Product Labels -----	29
8. List of Compatible Handpieces -----	29

1. Overview and Major Components

1-1. Delivery system with Vac Pac and Light

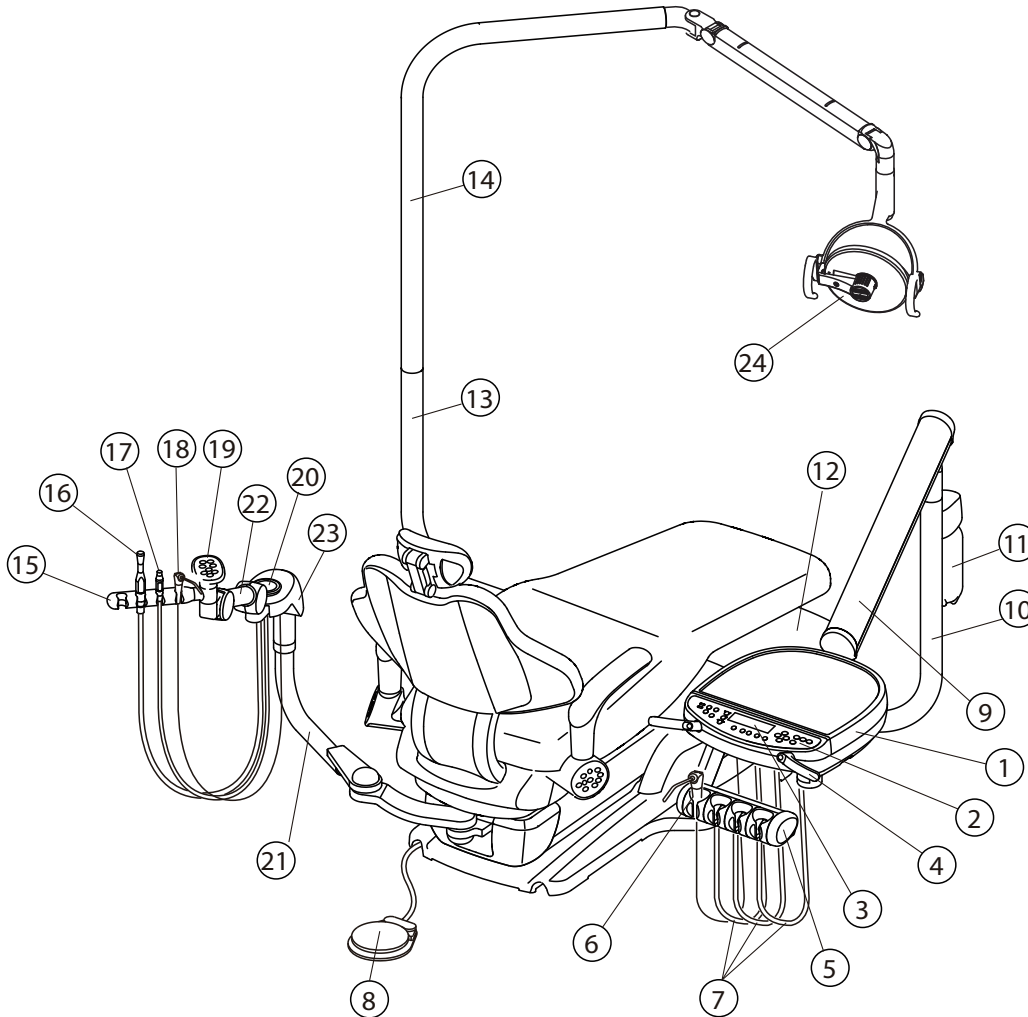

- | | |
|-----------------------------|----------------------------------|
| (1) Control Head | (15) Assistant Instrument Holder |
| (2) Main Control Panel | (16) HVE |
| (3) Digital Display | (17) SE |
| (4) Handle | (18) Assistant's Syringe (*) |
| (5) Handpiece Holders | (19) Assistant Touch Pad |
| (6) Dr's Syringe (*) | (20) Solids Collector |
| (7) Handpiece Hose | (21) Assistant Swing Arm |
| (8) Foot Control | (22) Assistant Holder Arm |
| (9) Balance Arm | (23) Vac Pac Housing |
| (10) Dr Swing Arm | (24) Dental Light |
| (11) Water Bottle | |
| (12) Junction Box | |
| (13) Dental Light Swing Arm | |
| (14) Light Pole | |

(*Note) Quolis 5000 series does not include syringe tips. Syringe tips manufactured by DCI are compatible with syringes used with this delivery system.

1. Overview and Major Components

1-2. Delivery system with Cuspidor section and light

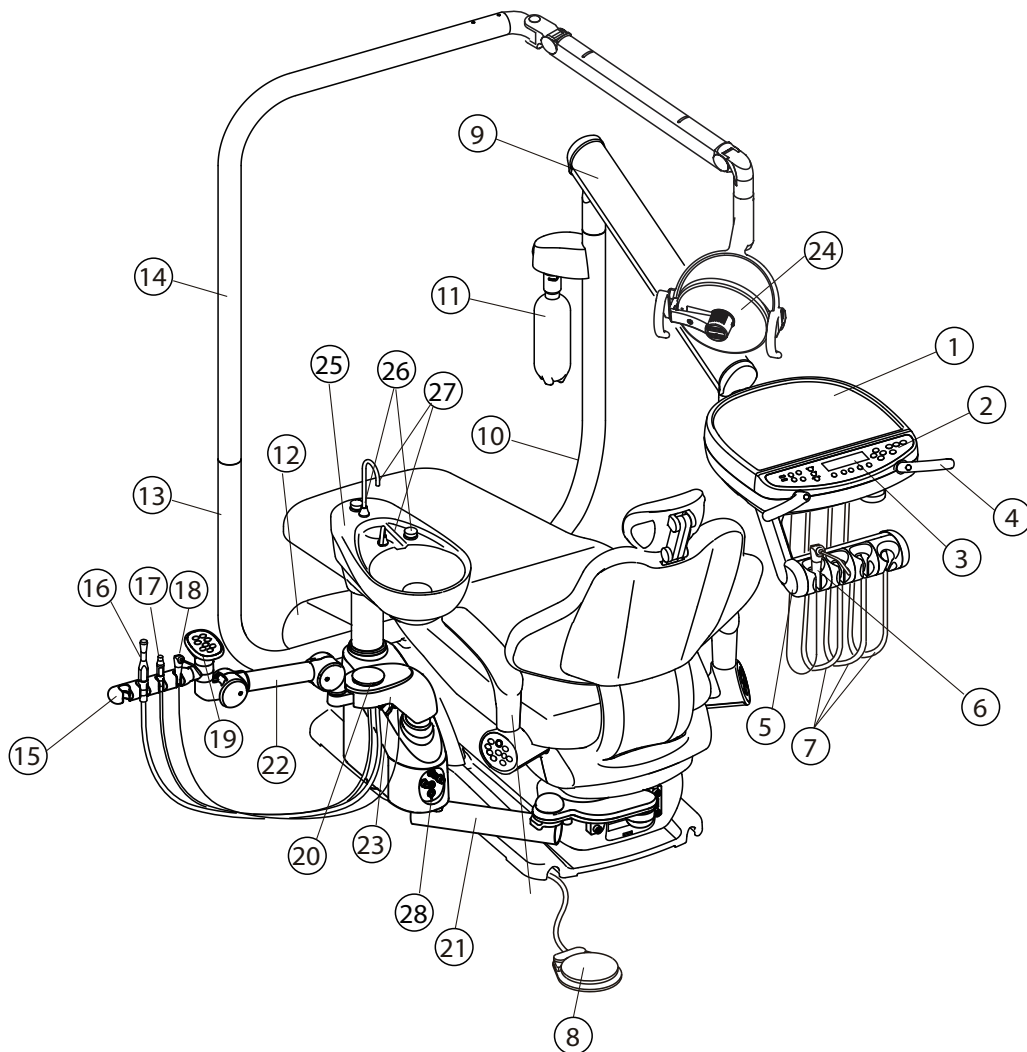

- | | |
|-----------------------------|---|
| (1) Control Head | (15) Assistant Instrument Holder |
| (2) Main Control Panel | (16) HVE |
| (3) Digital Display | (17) SE |
| (4) Handle | (18) Assistant's Syringe (*) |
| (5) Handpiece Holders | (19) Assistant Touch Pad |
| (6) Dr's Syringe (*) | (20) Solids Collector |
| (7) Handpiece Hose | (21) Assistant Swing Arm |
| (8) Foot Control | (22) Assistant Holder Arm |
| (9) Balance Arm | (23) Vac Pac housing |
| (10) Dr Swing Arm | (24) Dental Light |
| (11) Water Bottle | (25) Cuspidor bowl |
| (12) Junction Box | (26) Cupfill switch and bowl flush switch |
| (13) Dental Light Swing Arm | (27) Cupfill nozzle and bowl flush nozzle |
| (14) Light Pole | (28) PMU front panel |

(*Note) Quolis 5000 series does not include syringe tips. Syringe tips manufactured by DCI are compatible with syringes used with this delivery system.

2. Dimensions and Specifications

2-2. Delivery system with Cuspidor section

2-2-1. Dimensions

- Inch /(mm) -
- Tolerance $\pm 10\%$ -

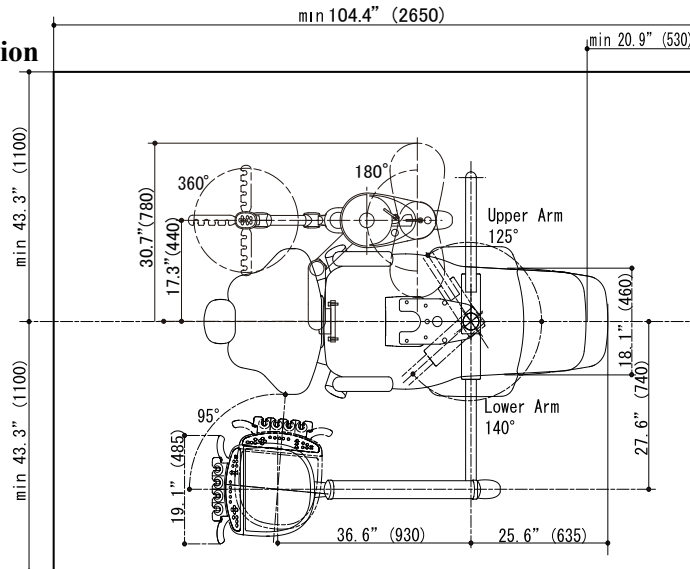

Minimum dimension for change to right and left position, excluding treatment space

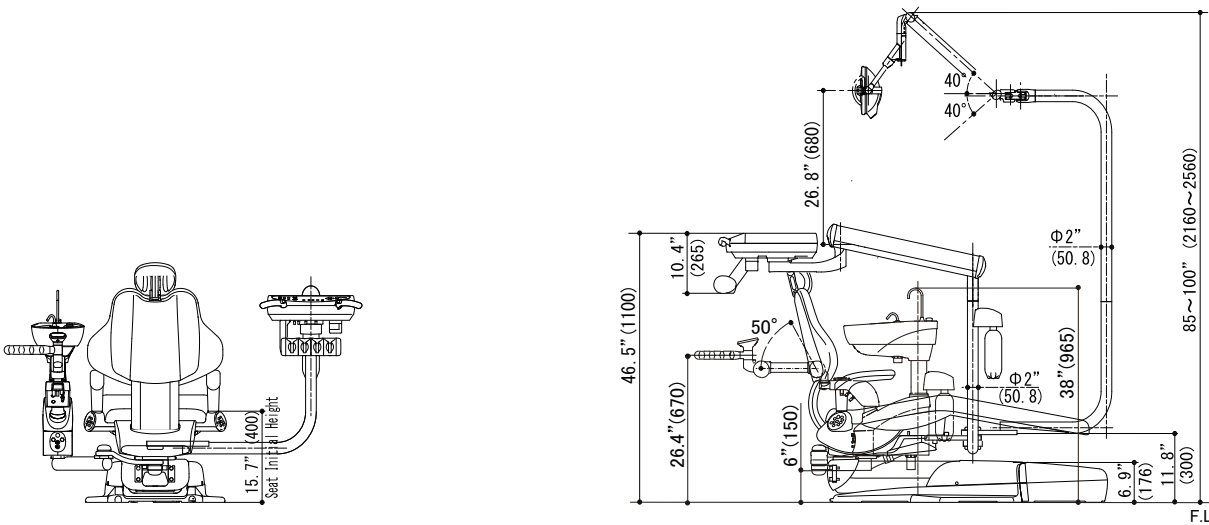

Fig.2-1 Dimensions

2-2-1. Specifications

Power Consumption-----	AC120V 1A
Frequency-----	60 Hz
Fuse value-----	AC125V 10A
Control Voltage-----	DC5V
Dr's control Net Weight-----	55 lbs (25 kg)
Swing Arm Net Weight-----	55 lbs (25 kg) (Without Dental Light)
Cuspidor Section Net Weight-----	66 lbs (30 kg)
Junction Net Weight-----	16 lbs (7 kg)
Doctor Table Maximum Load-----	4.40 lbs (2 kg)
Operating Pressure-----	Water 30-40 psi (0.2-0.28 Mpa), Air 75 psi (0.5 MPa)

3. Operating Instructions

3-1. Doctor Table Section

3-1-1. Master Switch (Fig.3-1-1 & Fig.3-1-2)

Turn on the master switch located under the doctor table, the power indicator on the main control panel will then illuminate green.

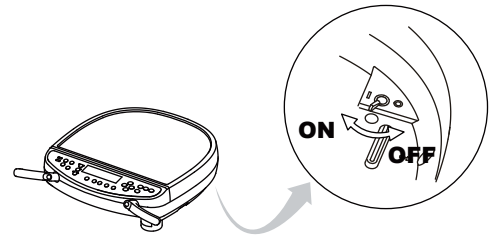

Fig.3-1-1 Master Switch

Important !

Turn off the master switch after daily operation and whenever operator is unattended

3-1-2. Control Panel

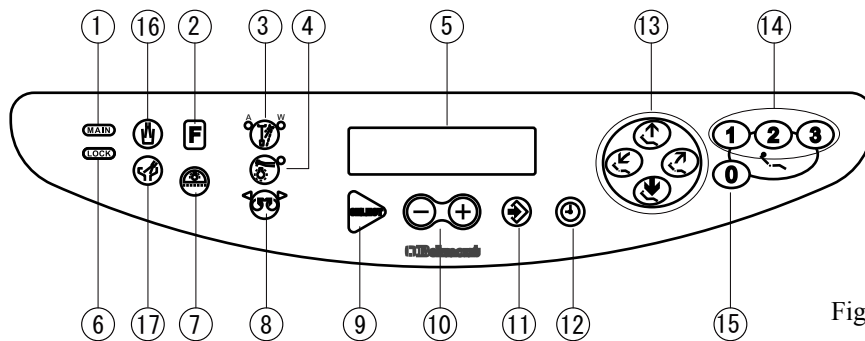

Fig.3-1-2 Main Control Panel

- | | |
|--|---|
| (1) Power Indicator | (9) Select Switch |
| (2) Function Switch | (10) Decreasing / Increasing Switch |
| (3) Spray Switch | (11) Store Switch |
| (4) Fibreoptic Light Switch | (12) Timer Switch |
| (5) Digital Display | (13) Seat position manual control switches |
| (6) Safety Lock Indicator | (14) Chair pre-set switches |
| (7) Dental Light Switch | (15) Chair Auto Return Switch |
| (8) Electric Motor Rotation Direction Control Switch | (16) Cupfill switch (Not available unless cuspidor is ordered) |
| | (17) Bowl flush switch (Not available unless cuspidor is ordered) |

(1) Power Indicator

Turn on the master switch, the power indicator will illuminate green.



Power Indicator

(2) Function Switch

Provides selection of unit functions (flush out operation, beeping on/off, fiber optic handpiece activation timing, the maximum speed of micromotor at variable modes, selection of doctor number, etc.) selected by the function switch.



Function Switch

(3) Spray Switch

Turning on/off the coolant air/water for instruments.

Micromotor has four mode selections (air and water / air only / water only / none).

Air turbine and air motor are available with two mode selections (air and water / none)

For electric scaler, only water is supplied.



Spray Switch

(4) Fibreoptic Light Switch

Pick up the fiber optic handpiece from the holder, momentarily press the Fibreoptic Light switch, the indicator illuminates in green and the light on the handpiece turns on. To switch off the light, simply press the Fibreoptic light switch again.

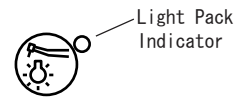

Fibreoptic Light Switch

(5) Digital Display

Visual display of settings

a) Operation after turning on the main switch

After Master Switch is turned on , the following is displayed and jobs are done :

- 1) All the LEDs on the control panel light up. Program No.(Ver. No) and Doctor No. are displayed.
- 2) Reading of the status of the instrument holders.
- 3) "Belmont" is displayed unless system problems are found.
- 4) After Master Switch is turned on, the above-mentioned process takes 5 seconds. Chairs cannot be operated during this period.

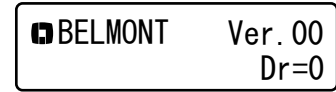

b) When handpieces are not properly placed in holders.

1) The controller detects the holder where the handpieces are not properly placed, controller beeps and displays the holder No(s) where handpieces are not properly placed.

Re-seat handpieces to stop beeping and restore normal handpiece operation.

2) If handpieces are not properly placed into the holders, they will not operate. Turn off main switch and place the handpieces in holder, turn main switch on again after 5 seconds.

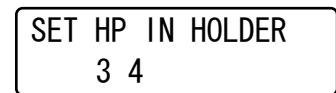

c) Automatic displa-sleep mode

After several seconds, the displays shuts off automatically and remains blank until any switch is pressed.

(6) Safety Lock Indicator

While the handpiece is running, the safety lock indicator illuminates amber and all seat positioning control switches will not operate.

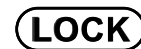

Safety Lock Indicator

(7) Dental Light Switch

Press the dental light switch to turn on/off the dental light.



Dental Light Switch

(8)Electric Motor Rotation Direction Control Switch (Optional)

After picking up the electric motor from the holder, the electric motor rotation direction can be changed by momentarily pressing this switch . The rotation direction will be indicated by the amber and green LEDs.

Indicator in green : Forward Rotation (Clockwise)

Indicator in amber : Reverse Rotation (Counter clockwise)

(Note : Do not change the electric motor direction while the motor is running. When motor rotation is set to reverse (counter-clockwise) rotation, a beep will sound when motor is removed from the holder.

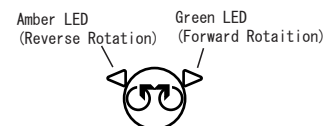

Electric Motor Direction Control Switch

(9) Select Switch

Selection of operation mode settings and functions.



Select Switch

(10) Decreasing / Increasing Switch

Press the switches to decrease/increase micromotor speed, scaler power, timer, alarm etc.



Decrease/Increase Switch

(11) Store Switch

Various settings can be stored into memory by pressing the Store switch. These settings will remain even if the Master switch is turned off.



Store Switch

(12) Timer Switch

Timer can be set at a maximum 90 mins. 59 secs., in 1 secs. increments. Set the time by momentarily pressing the timer switch and then the decrease/increase switch.



Timer Switch

(13) Chair Manual Control Switches

- 1) Seat Raising -----Press the (↑) switch until the seat is raised up to the desired position.
- 2) Seat Lowering-----Press the (↓) switch until the seat is lowered to the desired location.
- 3) Backrest Reclining-----Press the (↖) switch until the backrest is reclined to the desired position.
- 4) Backrest Raising -----Press the (↗) switch until the backrest is raised up to the desired position.

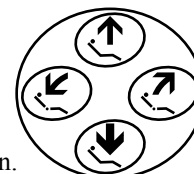

Chair Manual Control Switches

(14) Chair Pre-set Switches

Preset Operation

There are three pre-sets : 1, 2, 3. Pre-sets can be selected by momentarily pressing desired switches.

Seat positioning presets can be set by the operator to conveniently position patients for procedures. (Note:For pre-set position adjustment and auto-return, refer to chair operation manual.)

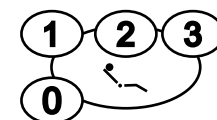

Chair pre-set switches

(15) Chair Auto Return Switch

1) Momentarily press the auto return switch (0) the chair returns to the initial position (the seat is the lowest position and the backrest is the upright position).

2) Emergency Stop (Safety Stop)

Pressing any chair control switch while the seat is in motion, automatically stops all



Auto Return Switch

⚠CAUTION

To avoid the potential for patient and operatory injury :

- Patient must be fully seated on the chair against backrest, with legs and heels on the seat and hands on top of the armrest before chair is operated.
- Operator and assistant must keep feet and hands clear from chair, until patient has been moved into treatment position.

To avoid the potential for damage to chair, delivery system and other furniture :

- Keep area around chair free from objects that might be damaged by chair when it is motion.

(16) Cupfill and bowl flush (unlinked)

1) Cupfill switch

Press this switch (☺) to supply water to cup from the cupfill nozzle. Water is supplied for about four seconds, by timer. Press this switch again to stop the water supply at any time.



Cupfill switch

2) Bowl flush switch

Press this switch (☹) to supply water from the bowl flush nozzle to clean the cuspidor bowl. Flush water is supplied for about six seconds by timer. By press and hold for two seconds, it makes a beep and water will be continuously supplied. Press this switch again to stop the water supply.



Bowl flush switch

(17) Cupfill and bowl flush (linked)

1) Cupfil switch

Press this switch  to supply water to cup from the cupfil nozzle

Water is supplied for about four seconds by timer.

At the same time water is supplied from the bowl flush nozzle for about six seconds.

Press this switch again at any time to stop the water supply to cup.

Press bowl flush switch  to stop water supply to cuspidor



Cupfill Switch

2) Bowl Flush switch

Press this switch  to supply water from the bowl flush nozzle and clean the cuspidor bowl.

Flush water is supplied for about six seconds by timer.

By press and hold for two seconds, it makes a beep and water will be continuously supplied.

Press bowl flush switch  again to stop water supply to cuspidor



Bowl Flush Switch

3-1-3. First priority function of the instruments

The priority of the operation is given to the handpiece that has been withdrawn first.

Only that handpiece will be operable.

1) After all the handpieces are placed in the holders, the first handpiece withdrawn will be operable. When more than one handpiece are withdrawn and the first one removed is returned to the holder, "Return to the holder" will be displayed. After the second or third handpiece is placed back to the holder, then withdraw again the handpiece that you want to use.

2) The operable handpiece number will be displayed (see example)

3) The handpiece will not be operable and the orange LED for rotation direction (counterclockwise rotation) will be lit if it is withdrawn while the foot control is pressed. Make sure to withdraw the handpiece before pressing the foot controller.

Return to holder

No3

3-1-4. Unit Supplement Functions

A. Spray Switch

1) Turning on/off the coolant air and water for handpieces.

1- 1) Pick up the handpiece from the holder.

1-2) Select spray mode 

2) The coolant air and water for instrument can be supplied in several combination.

For micromotor, [Four Mode] can be selected. , Air and water / air only / water only / none.

For air turbine and air motor, only [Two Mode] is available. Air and water / none.

For electric scaler, only water is supplied.

3) Set Four Mode or Two Mode

3-1) Press F switch  and repeat until the display becomes like the example at right.

3-2) Press the decrease switch  for two mode

3-3) Press the increase switch  for four mode

(Not after pressing the function switch  decrease / increase switch  /  must be pressed within 10 seconds.

4) Setting and memory

After desired spray mode has been selected, momentarily press store switch  to put it into memory.

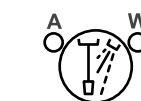

Spray Switch

SPRAY=4MODE F= ↓
(-) = 2 (+) = 4 MODE

B. Fiber optic handpiece lighting mode (Optional)

If a fiber optic handpiece is installed, two light activation modes can be selected.

H (holder) mode : Light source turns on when the handpiece is taken out of the holder, and turns off when the handpiece is returned to the holder.

F (foot control) mode : Light source turns on when the handpiece is taken out of the holder and foot control is pressed.

Setting

1) Press F switch **F** and repeat until the display becomes like the example below at right.



Function Switch



Decrease/Increase Switch

2) Press the increase switch (+) for H (holder) mode.

Press the decrease switch (-) for F (foot control) mode.

(Note: Press any of the above keys in 10 seconds after pressing function switch)

3) Press store switch without rotating the instruments to put it in memory.

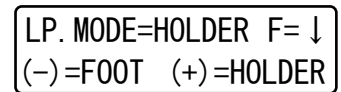

C. Maximum Rotation Speed of Micromotor

Select the maximum rotation speed setting . The maximum speed depends on the model of the micromotor used.

The set speed will remain until the master switch is turned off. It will not be stored in to memory. Speed setting can be stored into memory by pressing the store switch after speed selection. When two micromotors are used, the settings can be adjusted for each one independently.

1) Press select switch (SELECT) until “Va” is displayed on top of the display.

2) Press the decrease switch or increase switch (-/+) to change the maximum speed.

for Bien Air MX

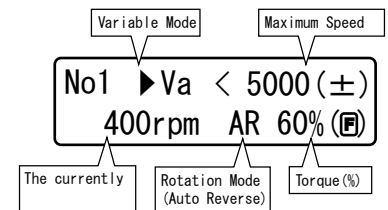

for DA-700(No torque adjustment)

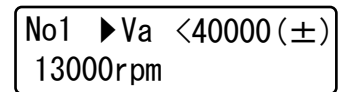

The Maximum speed of micromotor at the variable speed mode can be selected between “three steps” or “five steps”. At three steps, the maximum speed will be 5000, 10000 and 40000 rpm. At five steps, the maximum speed will be 1000, 5000, 10000, 20000 and 40000rpm. These are ranges for MX. The rotation speed range depends on the model of the micromotor. See the tables below this.

1) Press F switch **F** and repeat until the display becomes like the example at right. and press the (-) decrease switch for three step speed mode.

2) Press F switch **F** and repeat until the display becomes like the example at right. and press the (+) increase switch for three step speed mode.



Function Switch



Decrease/Increase Switch

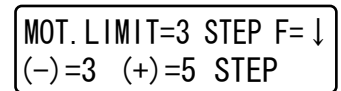

MX	3 steps	5 steps
	100 - 5000	100 - 5000
	1000 - 10000	1000 - 10000
		1000 - 20000
	1000 - 40000	1000 - 40000

DA-700	3 steps	5 steps
	2000 - 10000	2000 - 10000
	2000 - 20000	2000 - 20000
		2000 - 30000
	2000 - 40000	2000 - 40000

D. Rotation Speed Control Knob (Optional)

Turning the rotation speed control knob changes the rotation speed of the micromotor.

(Note: When using the micromotor depress the foot control to obtain enough air to prevent overheating of the micromotor.

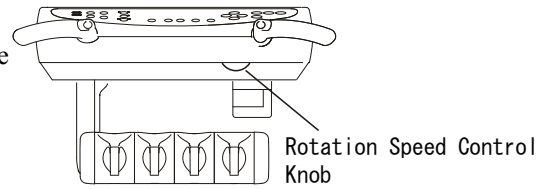

E. Pre-set Rotation Speed Mode



This function can provide constant speed of electric motor up to three different speed(M1,M2,M3).

The set speed remains until the Master Switch is turned off and will not remain in memory. To store in memory press the Store switch.

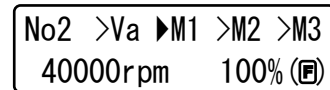
- 1) Pick up the electric motor from the holder.
- 2) Momentarily press the select switch() and continue to press it until desired setting figure is displayed on digital display.



Changing the setting speed.

- 1) Pick up the electric motor from the holder.
- 2) Momentarily press the decrease/increase switch() and repeat it until desired setting figure is displayed in the digital display.
- 3) Set up the required rotation speed by using increasing and/or decreasing switches.
- 4) Momentarily press Store switch() to store into memory.

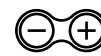
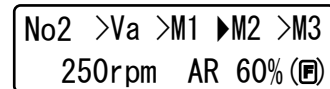

Decrease/Increase Switch



Store Switch

F. Torque adjustment of Bien Air MX





The followings can be adjusted.

- Torque of rotation (%)
- Rotation mode (normal, auto forward, auto reverse)
- Time of reverse rotation at auto forward setting
- The intensity of the light

The setting can be done both for variable rotation mode and pre-set rotation mode.

Torque adjustment and rotation mode changes can only be done in the low rotation speed range (100 to 5000 rpm). The torque remains 100% at high rotation speed (over 5000 rpm).

Setting

- 1) Withdraw MX motor from the holder
- 2) Press F switch() and hold until the display becomes like the example at right.
- 3) Press [Select ] and select the item to adjust.
- 4) ">" will be displayed at the left side of the item to be adjusted.
- 5) Press decrease / increase switch() to adjust.
- 6) To finish the setting, press Store switch(). To cancel, press 

•Torque Setting

The torque can be adjusted in the range of 10 to 100%

In high speed rotation mode, the torque stays 100%.

The actual torque value may change depending on the power input or the status of the motor.

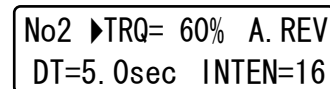

Function Switch



Select Switch



Decrease/Increase Switch



Store Switch

•Rotation mode

1)NOR(Normal Mode)

The motor rotates in one direction regardless of the load on the motor.

2) A. Rev (Auto reverse)

The motor stops when a specific (programmable) torque has been reached and begins turning in the opposite direction. When you stop the motor and restart, the motor will turn in the original direction.

3) A.FOW Auto Forward

The motor stops when a specific (programmable) torque has been reached and begins turning in the opposite direction, then after a specific (programmable) period (0.5 - 9.0sec), motor will automatically begin rotating in the original direction again.

Note : The actual time of rotation in the opposite direction in Auto Forward mode is slightly longer than displayed.

Intensity of the light of micromotor

The intensity of the light of MX micromotor can be adjusted, within the range of 00 to 15.

Note : The intensity of the light of other handpieces is fixed and cannot be adjusted.



No2 TRQ= 60% ▶A. FOW
DT=5.0sec INTEN=16



No2 TRQ= 60% A. FOW
▶DT=5.0sec INTEN=16

No2 TRQ= 60% A. FOW
DT=5.0sec ▶INTEN=10

G. Timer

Timer can be set at a maximum 90 mins. 59 secs. in 1 sec increments. Preset time

1) Momentarily press the timer switch , then press the select switch  to choose desired preset number (0 > 1 > 2 > 3).

2) Press the decrease switch or increase switch  to change the time. Press the select switch  to switch from minutes to seconds.

3) Momentarily press the timer switch  to start timer. The setting time is indicated on the function indicator.



(Note:The preset time remains until the master switch is turned off. Press the Store switch to put it in memory)

Preset Time Adjustment

Four preset times can be set. (0 > 1 > 2 > 3)

1) Momentarily press the  timer switch.

2) Press the select switch  and select the preset number 0.

3) Press the decrease switch or increase switch  to change the time. Press the select switch  to switch the minutes or seconds.

4) Press the store switch , then time is stored in the memory.

5) Preset time 1, 2 and 3 can be stored by repeating steps 2 through 4 above.

Note : After setting timer preferences, press timer switch  within 10 seconds.



Timer Switch



Select Switch



Decrease/Increase Switch



Store Switch

TIMER ▶0 >1 >2 >3
>01m>00s (±) START (⊙)

TIMER ▶0 >1 >2 >3
▶05m>00s (±) START (⊙)

BELMONT
08:43

Dr. NUMBER =0 F= ↓
PUSH 0 1 2 3 (LP)

FLUSH OUT F= ↓
(-)=40sec (+)=5min

BELMONT
08:43

H. Selection of Doctor Number

Up to four dentists can program their own settings for the following :

- 1) Pre-set speed of micromotor (3 speeds each) and on/off of the light.
(For MX micromotor, torque and rotation mode are also pre-programmable)
- 2) Timer of fibreoptic light option for air turbine after releasing the foot control.
- 3) Pre-set positions of the chair, 3 positions each.
- 4) Initial intensity (high / low) of the dental light (normal / composite).
- 5) The setting of function switch **F**.

Setting

1) Press F switch **F** and repeat until the display becomes like the example below at right.

The current doctor No. will be displayed.

2) Press any [Pre-set] switch 0, 1, 2 or 3. of the chair (**0**) (**1**) (**2**)
(**3**)

(Note: Doctor number must be selected within 10 seconds of pressing the function switch.



Function Switch



Chair Preset Switch

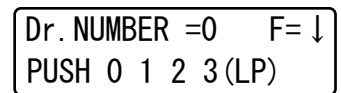

I. Flush out

The QUOLIS unit is designed with two handpiece flushout time durations.

Short time flush out - Cleaning handpiece water lines for 40 sec.

Long time flush out - Cleaning handpiece water lines for 5 min.

1) Operation

Press F switch **F** and repeat until the display becomes like the example at right. press the decrease switch **⊖** or the increase switch **⊕** (*Note). Pick up the handpieces from the holder and set them in a bucket, sink etc.

By momentarily pressing the foot control this starts the flush out. Water comes out from the handpiece and stops automatically after 40 seconds or 5 minutes.

During flush out, momentarily pressing of any switch of doctor table or foot control will cancel flush out immediately.

Note : Press **⊖** for short time (40 sec.)

Press **⊕** for long time (5 min.)

Note : Flush-out with the water bottle empty will purge out the water line with pressured air.



Function Switch



Decrease/Increase Switch

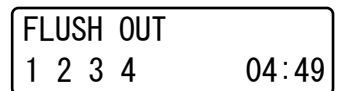
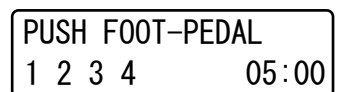
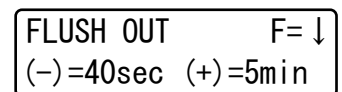



J. Control panel beeper on/off and adjustment

You can turn on/off or change the volume frequency of the beep heard.

Volume of the beep depends on the frequency.

1) Press F switch  and repeat until the display becomes like the example below at right.

Turn off the beep -----  press decrease switch

Turn on the beep -----  press increase switch

Higher frequency -----  press up switch

Lower frequency -----  press down switch

Default frequency -----  press 0 switch

2) After changing frequency, press increase switch

(Note : After pressing function switch, desired adjustment switch must be pressed within 10 seconds.

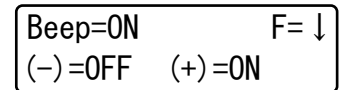
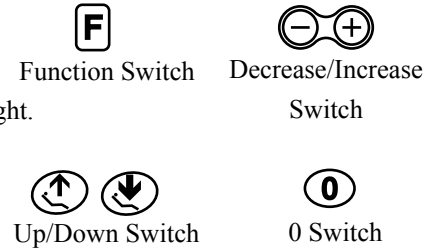





K. Alarm sound

Four types of alarm sounds can be selected.

Changing alarm sound helps dentists to recognize the device making the sound.

Setting

1) Press F switch  and repeat until the display becomes like the example at right.

2) Select alarm type 0, 1, 2 or 3 by pressing switch for pre-set positions of the chair () () () ()

(Note : After pressing function switch, desired alarm type must be pressed within 10 sec.)

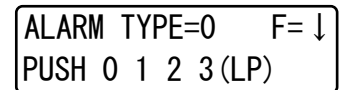
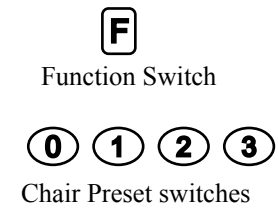

L. DA-150SL Varios Lux Scaler (Optional)

The Ultrasonic scaler can be set in 3 modes (perio / endo / scaling).

1) Pick up the handpiece of scaler and set the range by pressing  select switch.

2)The power of the scaling can be adjustable by pressing the decrease switch or increase switch.

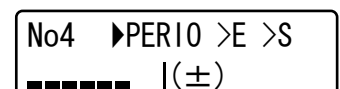
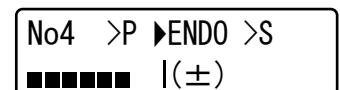
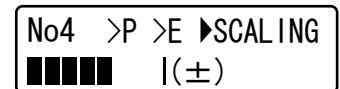
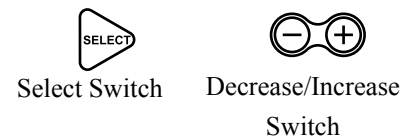

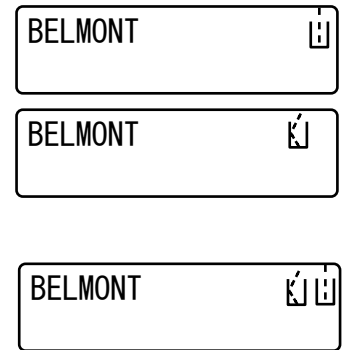

M. Switching on/off linkage of cupfill with bowl flush

- 1) Unlinked :
When cupfill switch is pressed, bowl flush does not start.
- 2) Linked :
When cupfill switch is pressed, bowl flush start as well as cupfill.





Setting

- 1) Press F switch  and repeat until the display becomes like the example below at right.
- 2) Press either of the following switches

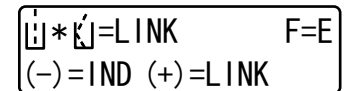
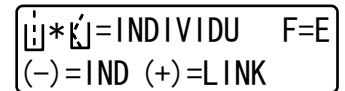
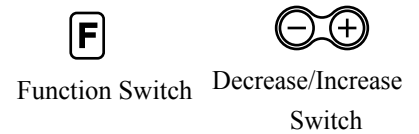
- Unlinked 
- Linked 



N. Display of time of cupfill and bowl flush

- 1) Press F switch  and repeat until it makes a short beep.
- 2) Press cupfill switch  to display the time of duration of cupfill.
- 3) Press bowl flush switch  to display the time of bowl flush.

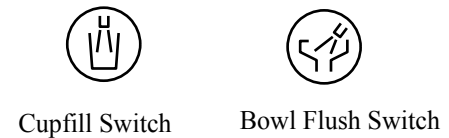

O. Setting the cupfill timer

- 1) Place an empty cup on the cup support on the cuspidor bowl.
- 2) Press F switch **F** and hold until it makes a short beep.
- 3) Press auto return switch **0** and the display becomes like the drawing at the right.
- 4) Press and hold cupfill switch . The time of the cupfill is programmed for the duration that the switch is being pressed.
- 5) After releasing the switch, the time will be displayed.

If you need to reprogram the time, press auto return switch **0** again and repeat the procedure 3) to 5).

In order to program the timer for bowl flush, press auto return **0** again.

Flow restrictor inside the gray metallic cover will control the water flow. Call service tech to adjust this.

0 0 Switch **F** Function Switch

TIME SET
DURING PUSH SW



Cupfill Switch

TIME SET

CUP FILLER TIME
00. 20sec

P. Setting the bowl flush timer

- 1) Press F switch **F** and hold until it makes a short beep.
- 2) Press auto return switch **0** and the display becomes like the drawing in the right.
- 3) Press and hold bowl flush switch . The time of the bowl flush is programmed for the duration that the switch is being pressed.
- 4) After releasing the switch, the time will be displayed.

If you need to reprogram the time, press auto return switch **0** again and repeat the procedure 2) to 4).

In order to program the timer for cupfill, press auto return **0** again.

Flow restrictor inside the gray metallic cover will control the water flow. Call service tech to adjust this.

TIME SET
DURING PUSH SW



Bowl flush switch

BOWL FLUSH TIMER SET

BOWL FLUSH TIME
00. 20sec

3-1-5. Doctor Table Section Controls

A. Handpiece Spray Water Control Knobs

The handpiece coolant water control knobs are located underneath the doctor table. Each handpiece coolant water control knob is identified as number 1 to 4 from the left side HP1,HP2,HP3,...

The handpiece coolant water volume can be controlled independently.

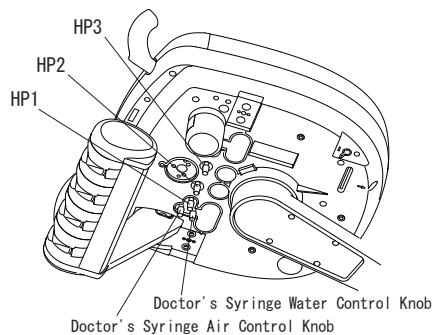

Doctor Table Section Control Knobs

B. Doctor's Syringe Flow Control Knobs

Doctor's syringe flow control knobs are located underneath the doctor table. The flow control knobs adjust the doctor's syringe air and water flow volume.

The yellow capped knob is the air flow control knob, the blue capped knob is the water flow control knob.

Note : Turning the control knob counterclockwise will increase the flow volume and turning clockwise will decrease.

Note) Quolis 5000 series does not include syringe tips. Syringe tips manufactured by DCI are compatible with this device.

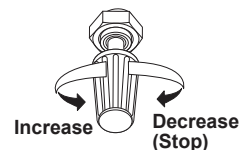

Control Knob

3-1-6. Handpiece pressure Gauge

Handpiece drive air pressure gauge is located in the doctor table. While a handpiece is working, the handpiece drive air pressure is indicated on the handpiece pressure gauge.

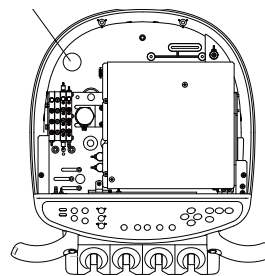

Handpiece Pressure Gauge

3-1-7. Balance Arm Air Brake

Balance arm air brake buttons are located on the handle.

Grasp the handle and press the air brake button to release brake and adjust the table height. Release the air brake button at the desired table position and the balance arm position will be locked.

Note : Do not place loads over 4 lbs on top of the doctor table.

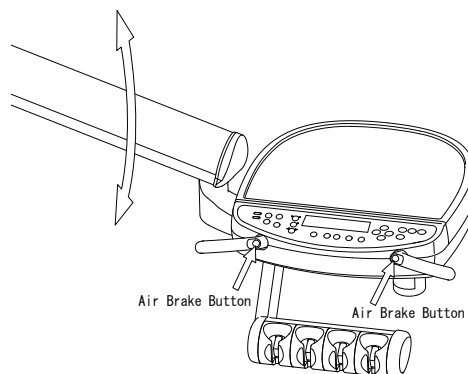

Balance Arm Air Brake

3-2. VAC PAC (ASSISTANT INSTRUMENTS)

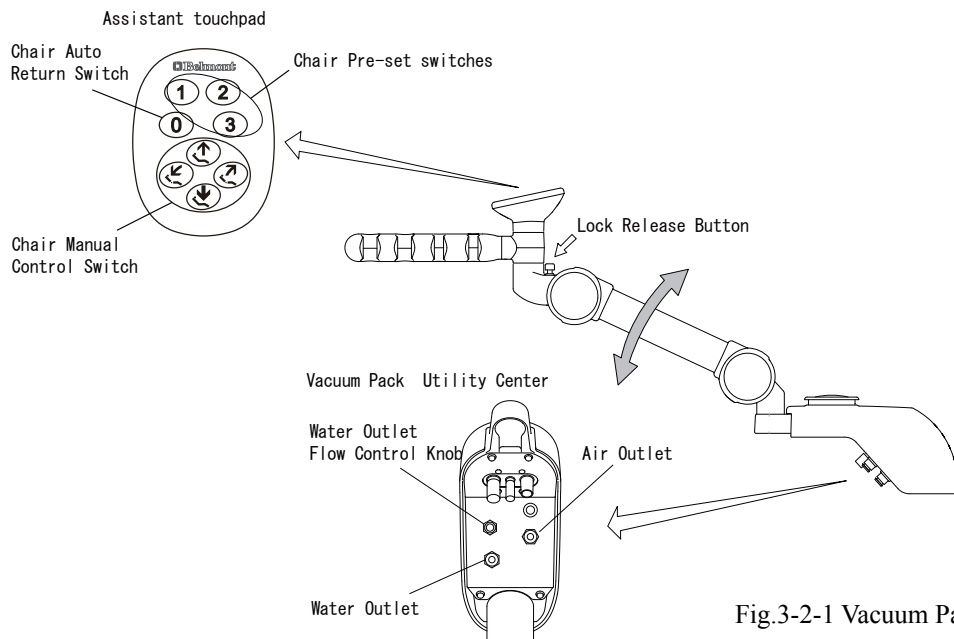

Fig.3-2-1 Vacuum Pack Section

(1) Assistant Touchpad (Fig.3-2-1)

Chair Preset switches and manual positioning switches are located on the touchpad.

(2) Vac Pac Utility Center(Fig.3-2-1)

A. Water Outlet with flow control(Fig.3-2-1)

The service water outlet provides a quick-connection and flow control for water.

B. Service Water Outlet Control Knob (Fig.3-2-1)

Outlet water volume can be adjusted by the outlet flow control knob.

Turning the knob counterclockwise will increase the flow volume and turning clockwise will decrease flow.

C. Service Air Outlet (Fig.3-2-1)

Service air outlet provides a quick-connection for air.

(3) Vacuum Pack height Adjustment (Fig.3-2-1)

Press the lock release button and raise arm to adjust the Vac pac height. Position at desired height and release the lock button **after that**.

Note : Support the arm with your hand until it is positioned at the desired height.

(4) Assistant's Syringe Control Knobs(Fig.3-2-2)

Assistant's syringe flow control knobs are located inside the housing cover.

Note : Turning a knob counterclockwise increase flow volume and turning clockwise will decrease.

Note) Quolis 5000 series does not include syringe tips. Syringe tips manufactured by DCI are compatible with this device.

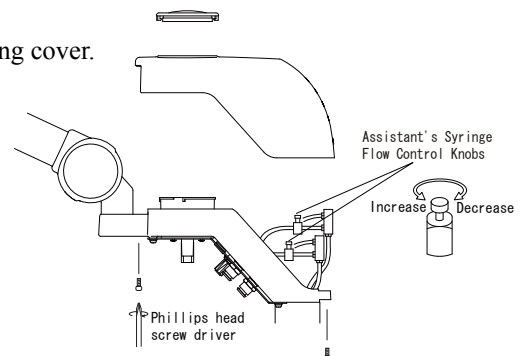

Fig.3-2-2 Assistant's Syringe Control Knob

3-3. Cuspidor Section (Cuspidor with assistant instruments)

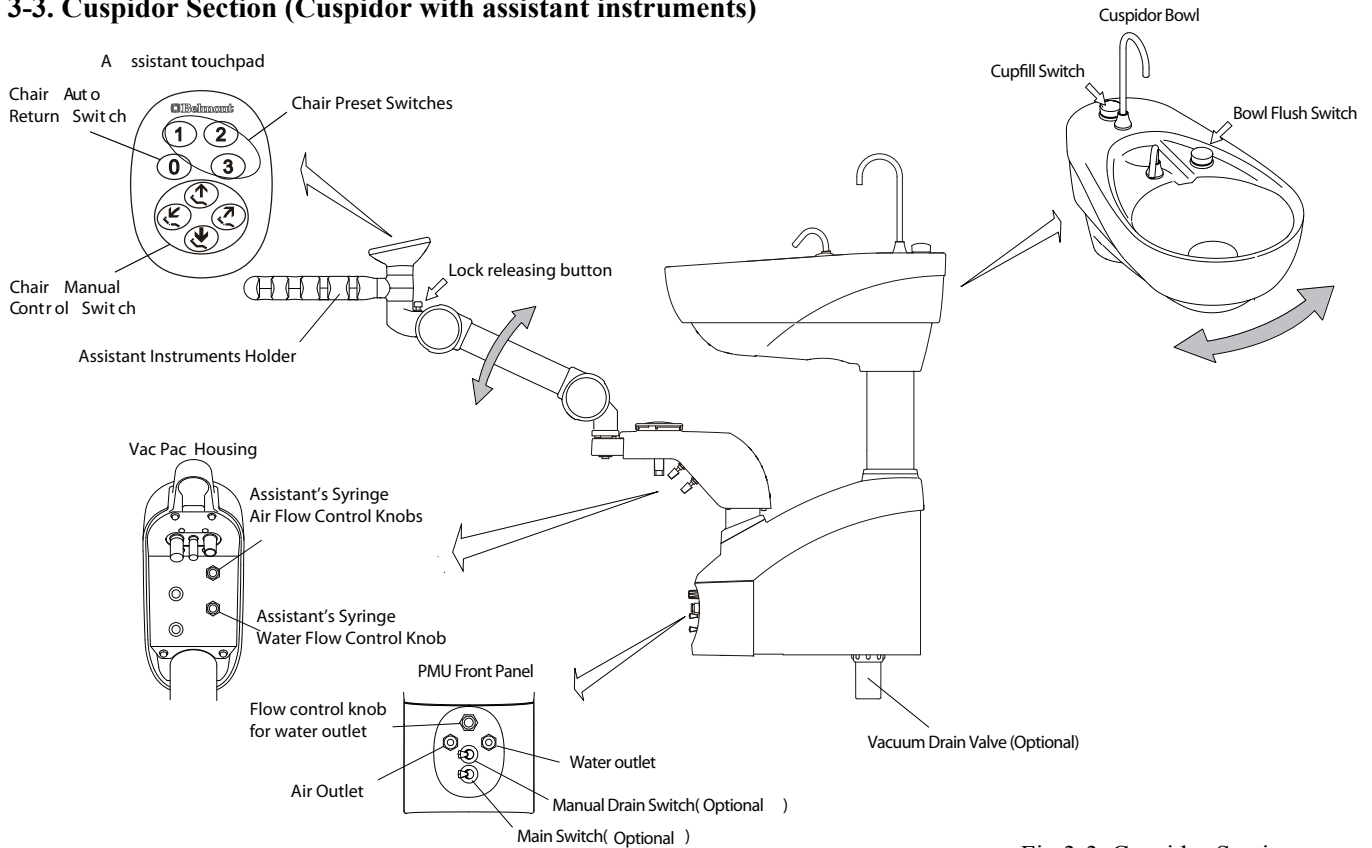

Fig.3-3 Cuspidor Section

(1) Assistant Touchpad (Fig.3-3)

Chair Preset switches and manual positioning switches are located on the touchpad.

(2) Vac Pac Housing (Fig. 3-3)

- A. Adjust water flow of syringe with the flow control knob with blue cap.
- B. Adjust air flow of syringe with the flow control knob with yellow cap.

(3) Vacuum Pack height adjustment(Fig. 3-3)

Press the lock release button and raise arm to adjust the height of assistant instruments holder. Position at desired height and release the lock button.
 Note : Support the arm with your hand until it is positioned at the desired height.

(4) Front Panel (Fig. 3-3)

A. Water Outlet with flow control(Fig.3-3)

A 1/4" female a quick-connection and flow control for water is provided.

B. Service Water Outlet Control Knob (Fig.3-3)

Outlet water volume can be adjusted by the outlet flow control knob.

Turning the knob counterclockwise will increase the flow volume and turning clockwise will decrease flow.

C. Service Air Outlet (Fig.3-3)

A 1/4" female a quick-connection for air is provided.

D. Manual Drain Switch (Optional) (Fig. 3-3)

Turn ON the manual drain switch  to manually drain the cuspidor bowl.

E. Main Switch (Optional) (Fig. 3-3)

This is the main power switch (pneumatic) for the system. This option is only needed if cuspidor is not connected to a delivery system with a Main Switch.

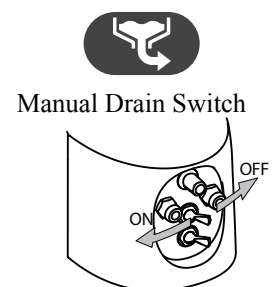

(5) Cuspidor bowl (Fig. 3-3)
(Not Applicable for QDU-5300 or QDU-5400)

A. Cupfill

Press cupfill switch to supply water from cupfill nozzle for the desired programmed time.

If cupfill is programmed to be linked to bowl flush, water is supplied from the bowl flush nozzle for a programmed time interval after cupfill is completed.

Press cupfill switch again to cancel cupfill.

Press bowl flush switch to cancel bowl flush.

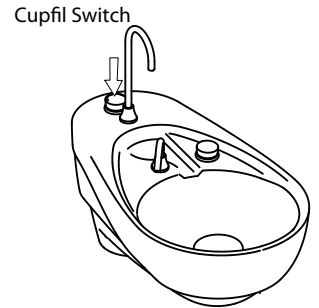

B. Bowl Flush

Press bowl flush switch to flush bowl for the disired programmed time interval.

Press bowl flush switch again to cancel bowl flush.

Press bowl flush switch and hold to supply water from bowl flush continuously.

Press bowl flush switch again to cancel bowl flush.

Cupfill switch may be pressed while bowl is being flushed.

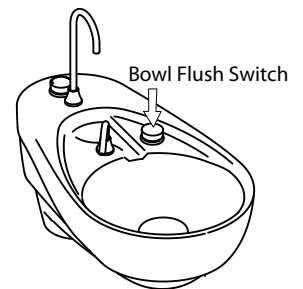

(6) Cuspidor bowl (Fig. 3-3)
(Applicable for QDU-5300 or QDU-5400)

A. Setting of linked/unlinked mode of cupfill and bowl flush

- 1) Turn the main switch on the front panel OFF
- 2) Pressing BOTH cupfill switch and bowl flush switch, turn ON the main switch.
- 3) A short beep indicates linked / unlinked status of cupfill and bowl flush.

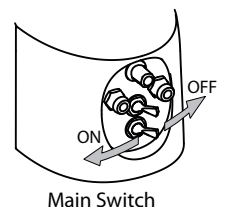
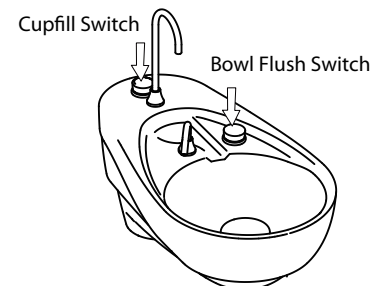

B. Setting of cupfill timer

- 1) Place a cup on the cup holder.
- 2) Turn the main switch on the front panel OFF
- 3) Pressing cupfill switch, turn ON the main switch. The system makes consecutive beeping and turns into in programming mode.
- 4) Press and hold cupfill switch for the time to program timer till water fills the cup at desired level. In order to add time, press and hold the cupfill switch again. The sum of the time being pressed is programmed.
- 5) To store the time into memory, press bowl flush switch and release.

Note : To cancel before storing the time into memory, turn the main switch off.
If bowl flush switch is pressed without doing (4), timer is programmed for 4 seconds.
The maximum time of cupfill is 12 seconds.



C. Setting of bowl flush timer

- 1) Turn the main switch on the front panel OFF.
- 2) Pressing bowl flush switch, turn ON the main switch. The system makes consecutive beeping and turns into in programming mode.
- 3) Press and hold bowl flush switch for the time to program timer. In order to add time, press and hold the bowl flush switch again. The sum of the time being pressed is programmed.
- 4) To store the time into memory, press cupfil switch and release.

Note : To cancel before storing the time into memory, turn the main switch off.
If cupfill switch is pressed without doing (3), timer is programmed for 6 seconds.
The maximum time of bowl flush is 12 seconds.

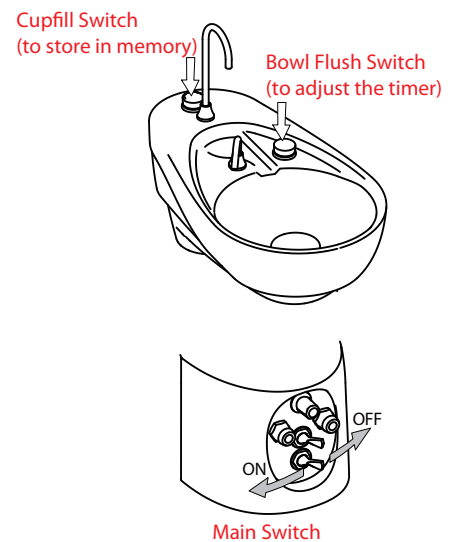

(7) Vacuum Drain Valve (Optional)

Make sure that the strainer is clean in order to maintain proper suction power.

Note :

When bowl flush switch is pressed, the cuspidor drain is switched on automatically. This causes noise which is created by suction.

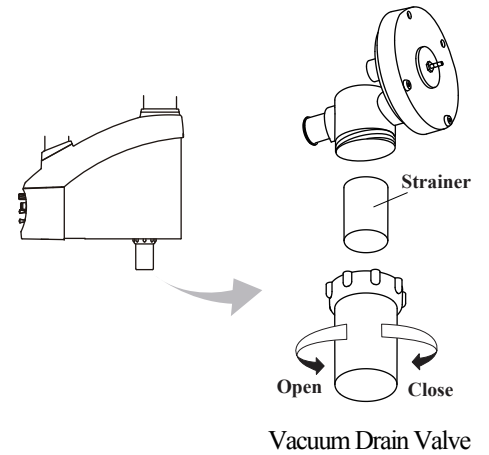

(8) Assistant Instrument Holder

Saliva ejector and HVE have levers to close and adjust suction power.

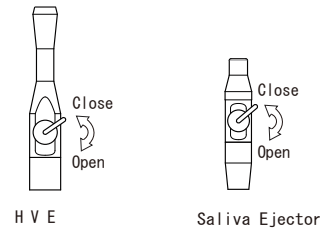

HVE and Saliva Ejector

⚠ CAUTION

Do not apply more than 6 lbs of weight on the holder section

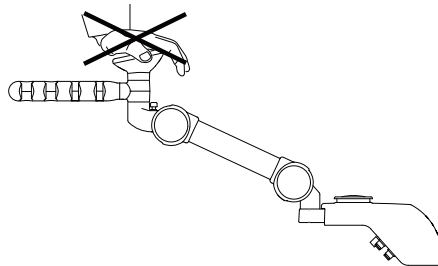

3-4. FOOT CONTROL SECTION

Pick up a handpiece from the handpiece holder and depress the foot control, the handpiece will start running.

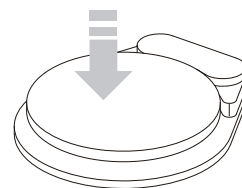

Foot Control

4. RIGHT / LEFT HANDED DENTISTRY CONVERSION

Swing arms can be positioned on the left and right sides of the chair.

1. Move the doctor table to the following position.

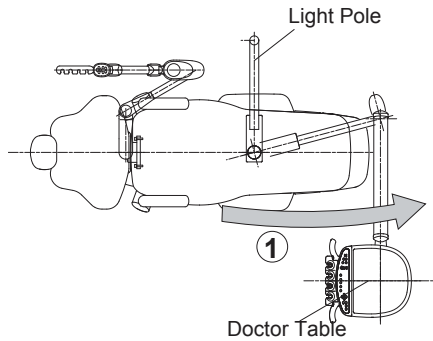

2. Remove locking pin on the light swing arm.

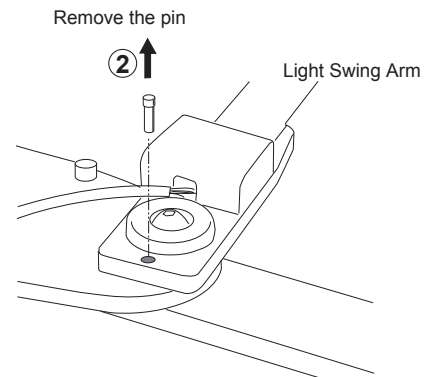

Note :Monitor mount arm does not need the locking pin

3. Lift the toe board of seat cushion and re-position the light and monitor swing arms on the other side of the chair.

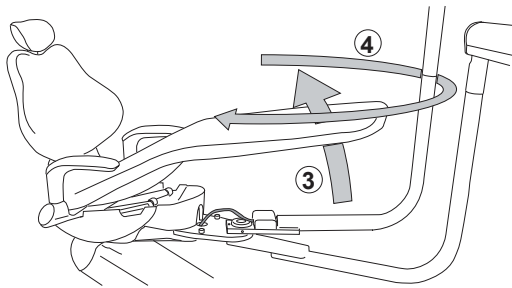

4. Swing the doctor's table to the other side as shown below.

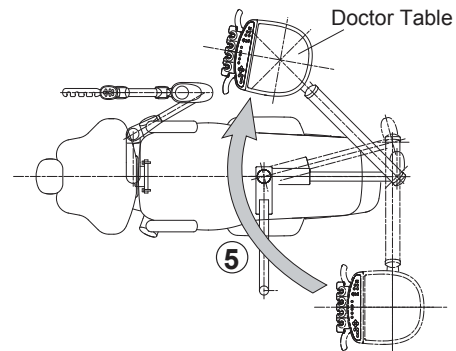

5. Swing the Vac Pac to the other side.

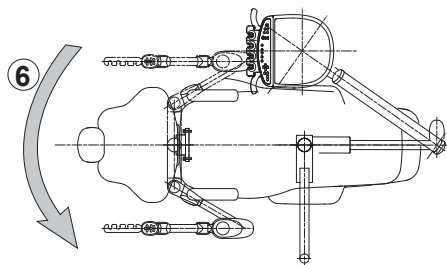

6. Swing the Cuspidor section to the other side

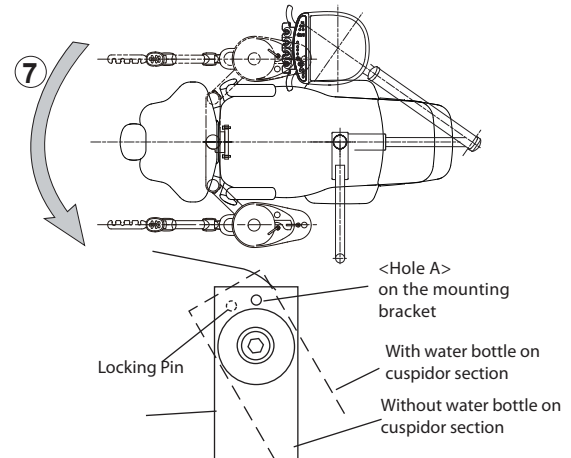

If cuspidor section is installed with water bottle, angle the swing arm forward and use <Hole A> to fix the position of swing arm, so it will not interfere with the bottle.

5. Care and Maintenance

⚠CAUTION

Turn the master switch off after daily operation and whenever operator is unattended.
Turn the main water shut off valve OFF after daily operation and for long term intervals.

(1) Cleaning

⚠CAUTION

Follow the manufacturer's instructions for all cleaning agents or disinfectants used on Quolis 5000 chairs, units and lights. Failure to do this may cause damage the equipment
Do not use sodium hypochlorite, bleach solutions or abrasive cleaners. These will damage the surface of the equipment.
Do not drench the chair and unit.
Wipe all surfaces dry after cleaning.
Do not spray directly onto the surface of the product.

(2) Solids Collector (Fig.5-1)

Clean solids corrector filter daily for optimum performance.

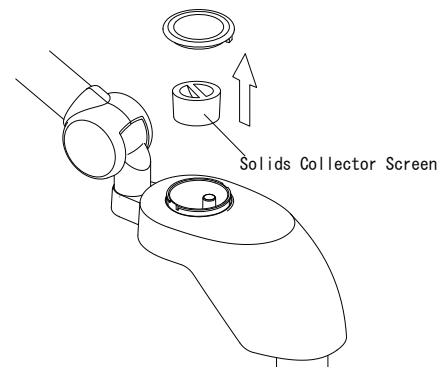

Fig.5-1 Solid Collector Filter

(3) HVE and Saliva Ejector(Fig.5-2)

A. Pull out the HVE from the hose and clean it.

B. After daily operation, run two cups of clean water through the suction line to clean inside.

Note : After cleaning the HVE and Saliva Ejector, apply a white vaseline lightly on the rubber O-Rings to prevent damage to this O-Ring.

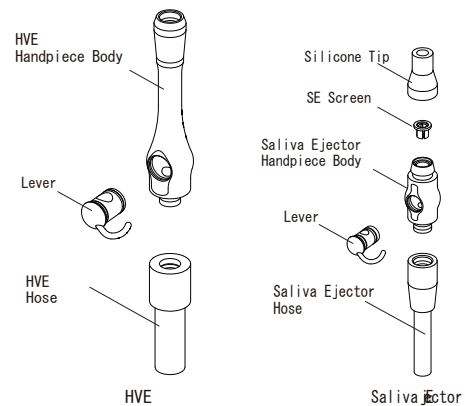
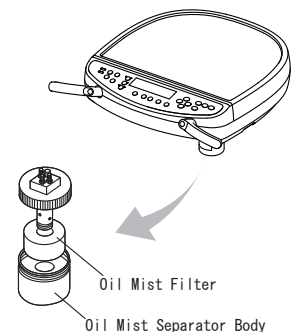

Fig.5-2 HVE and Saliva Ejector

(4) Oil Mist Separator

Handpiece oil mist separator is located underneath the doctor table. The oil contained in the exhaust air of each handpiece is collected in this container. Remove the container and clean the separator body and filter when oil reaches the level of the red line or at least once per week.



6. Flow Diagram

6-1. Doctor's control section

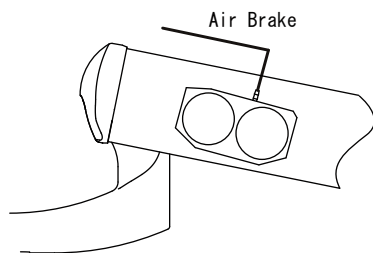
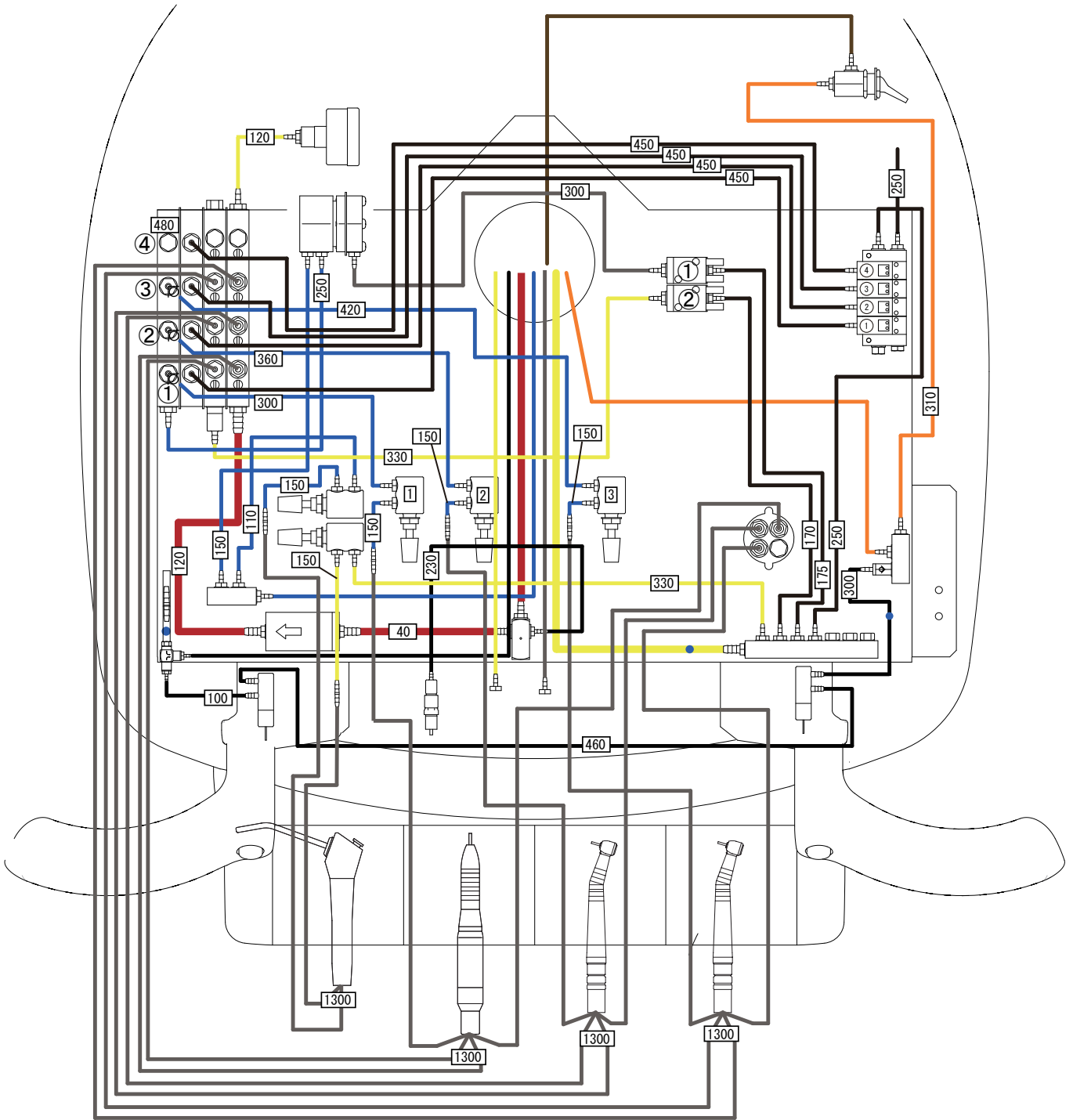

Air Brake

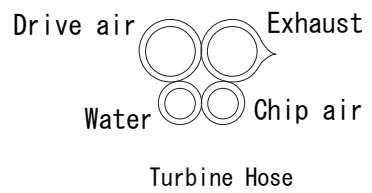

6-2 Swing Arm Section

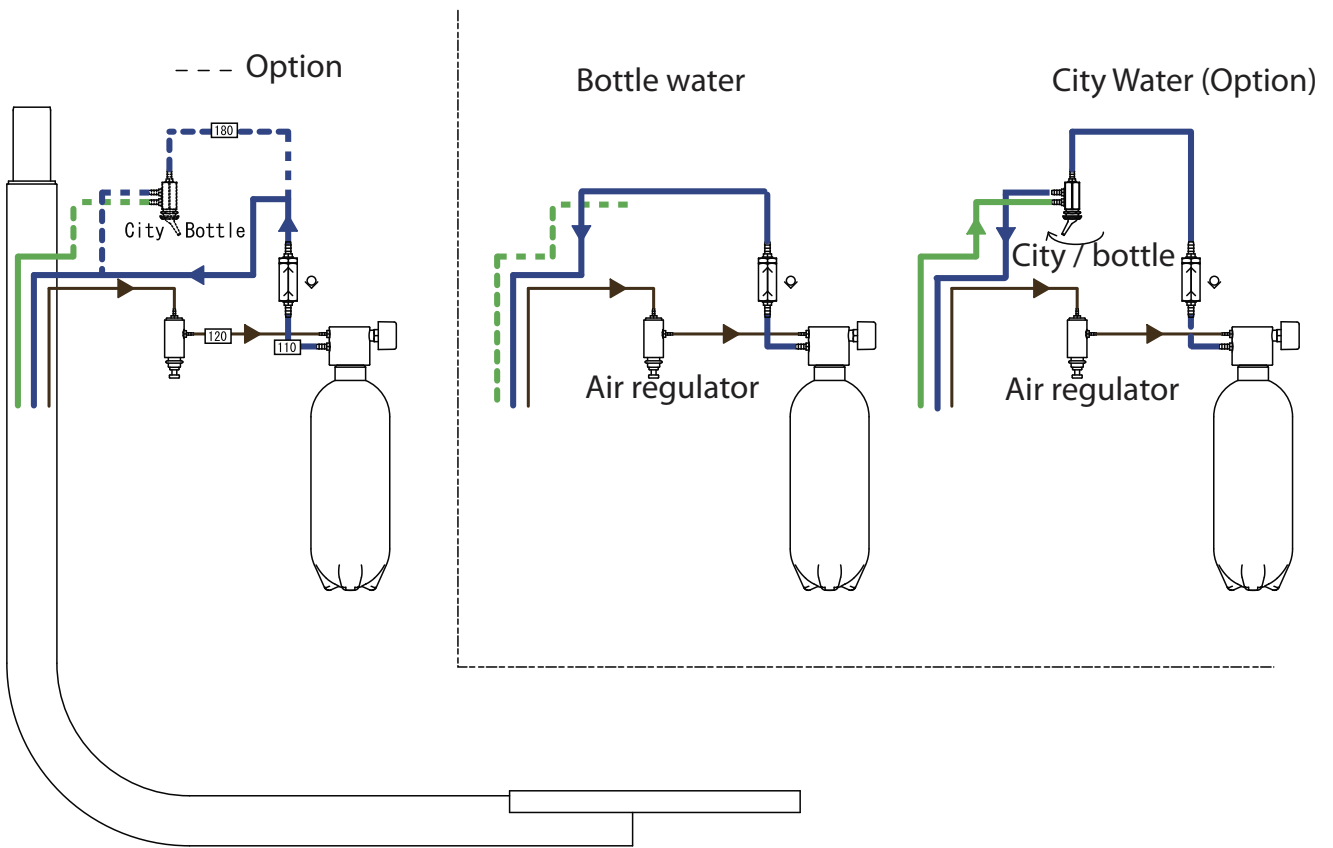

6-3 Vac Pac

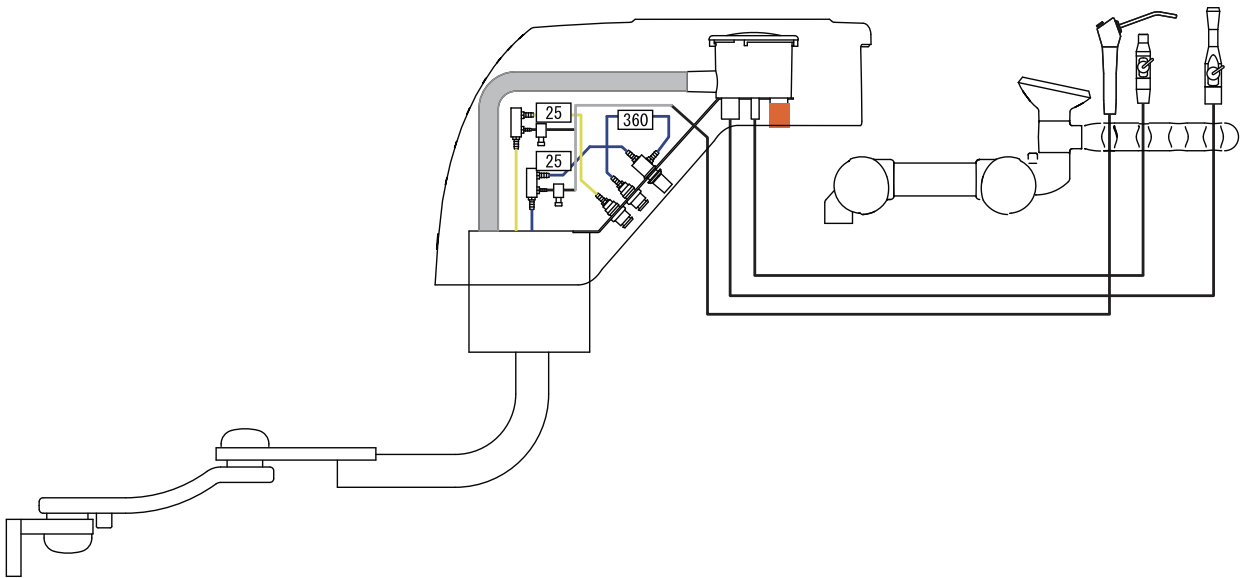

6-4 Cuspidor Section

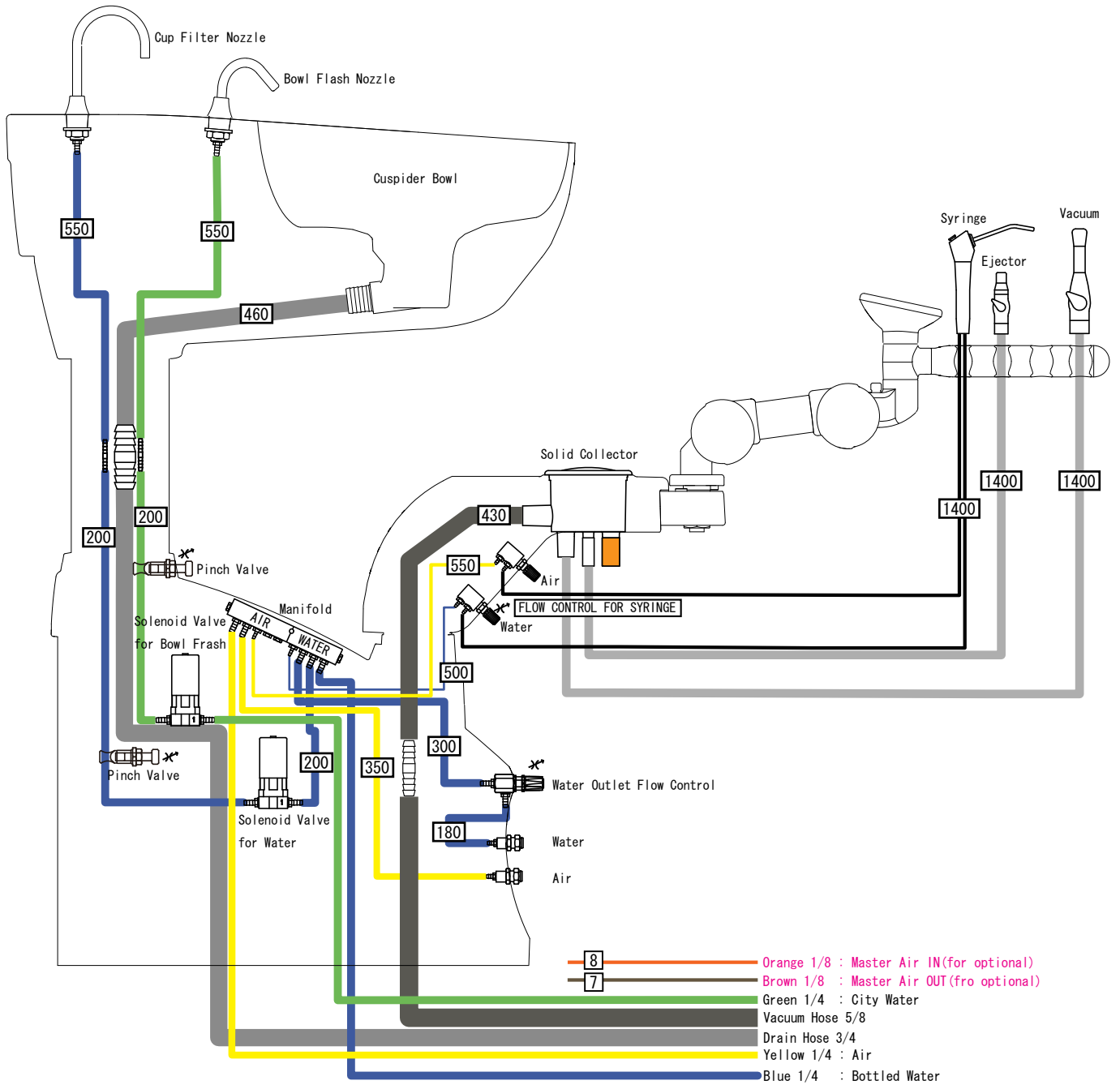

6-5 Junction Box Section

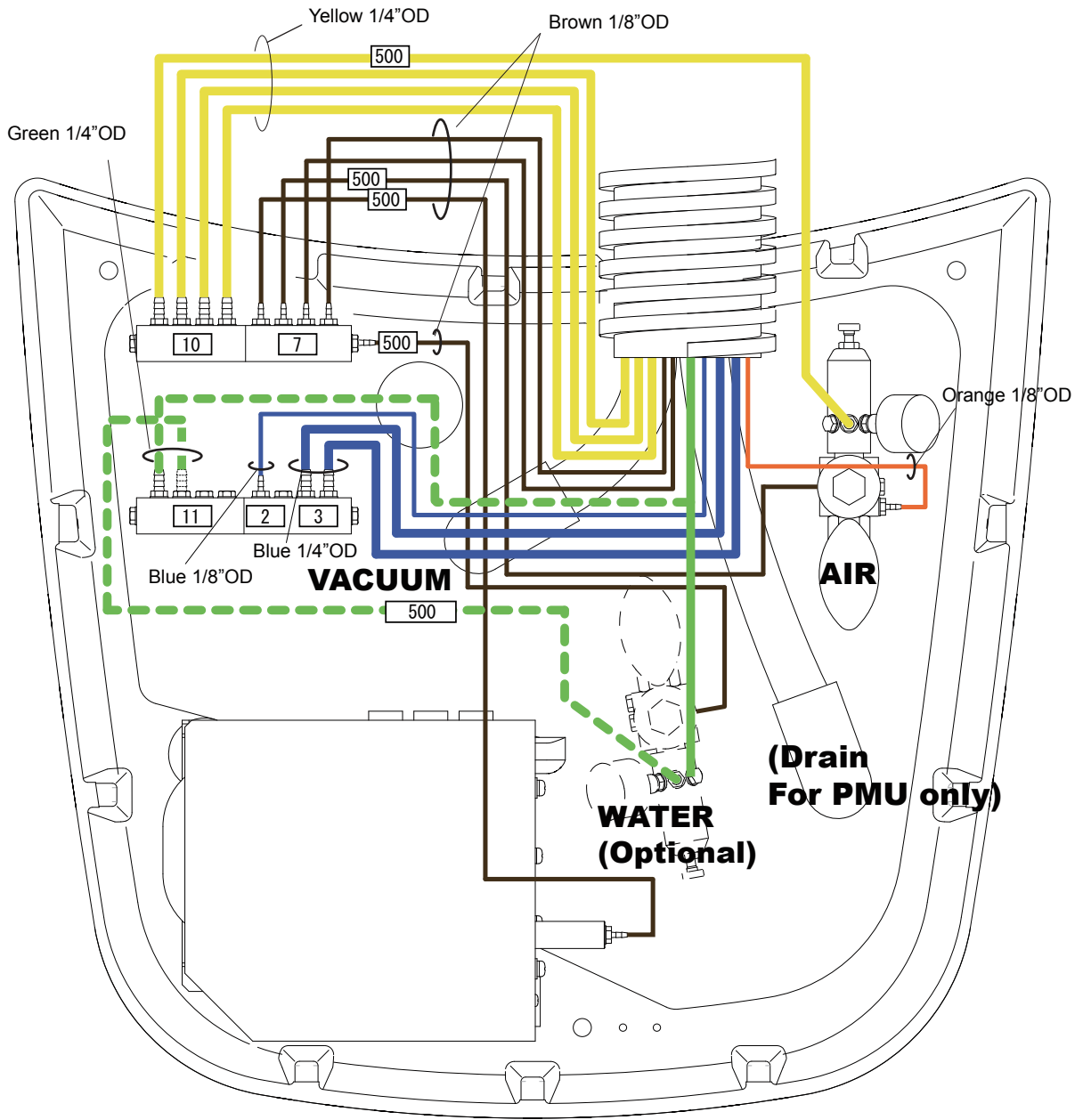

6-6 Overall Unit (Delivery system with Vac Pac)

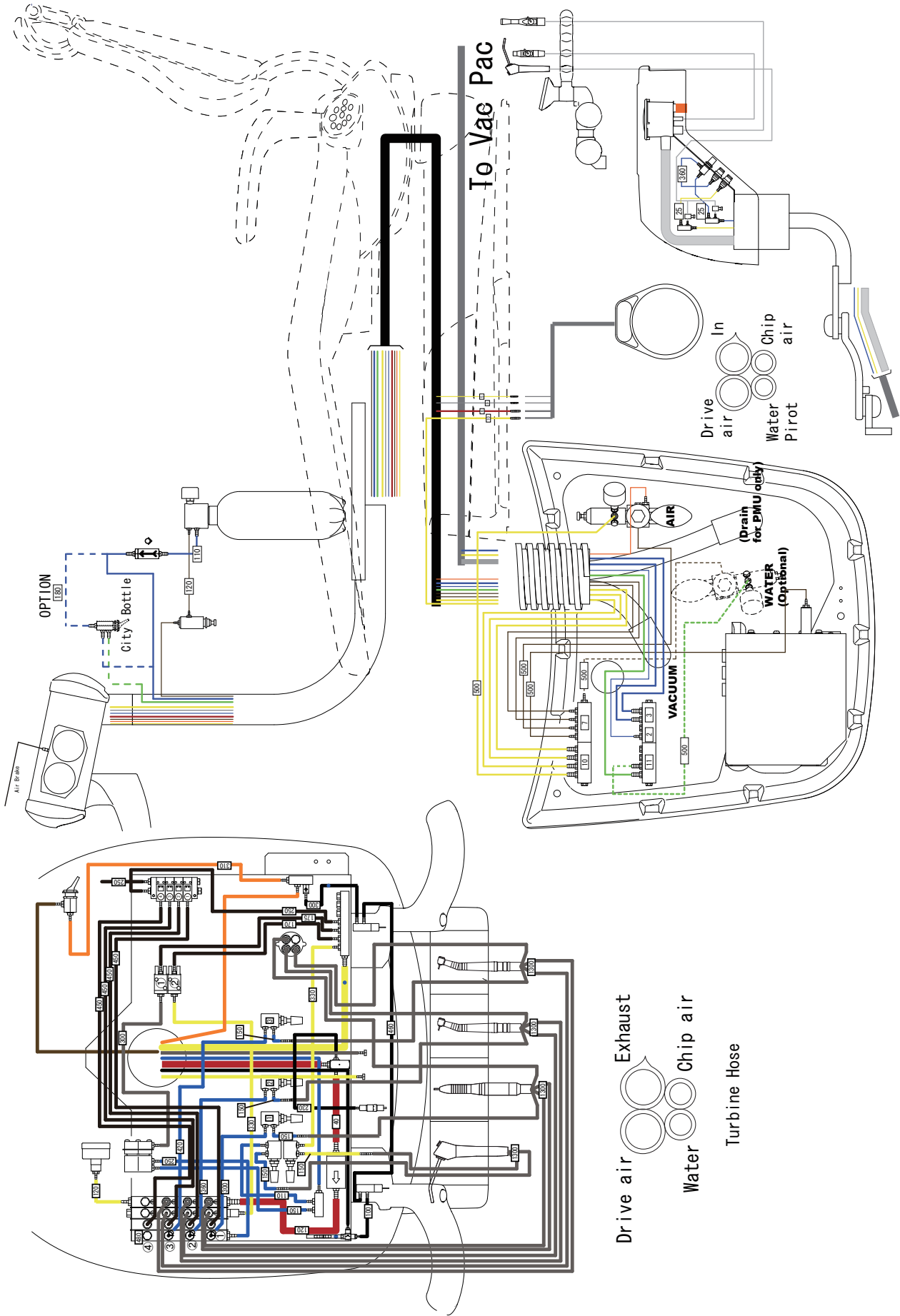

6-7 Overall Unit (Delivery system with Cuspidor section)

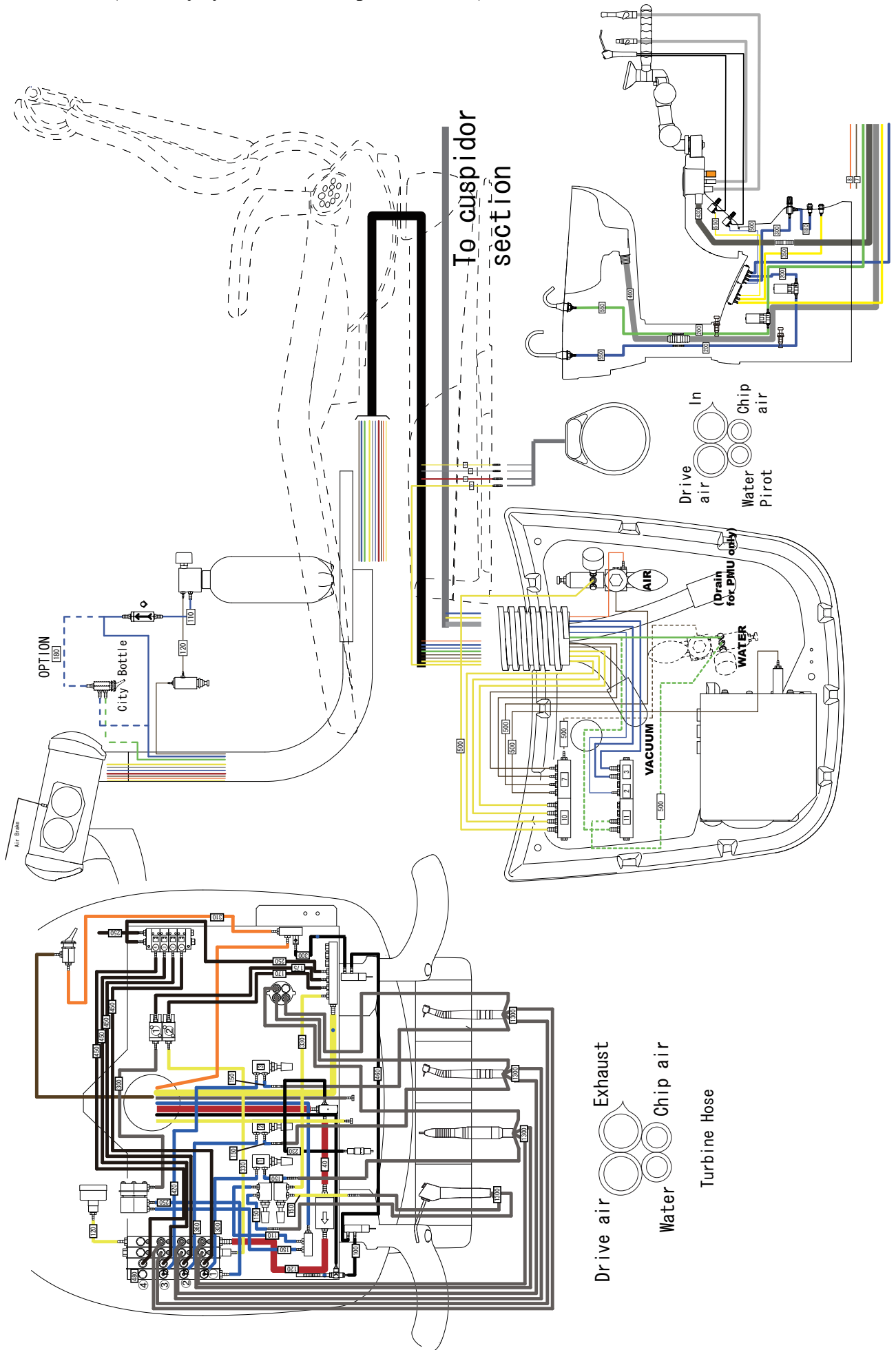

8. Location of the Product Labels

8-1. Product label & ETL label are located under the doctor table.

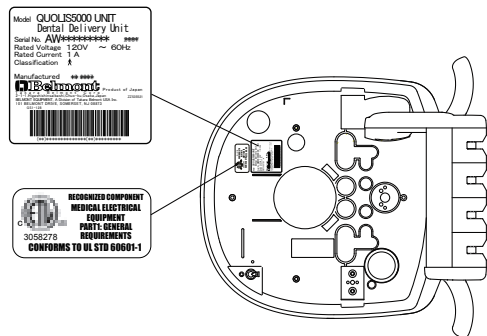

8-2. Product label (SERIAL No.) is located side of the assistant swing arm.

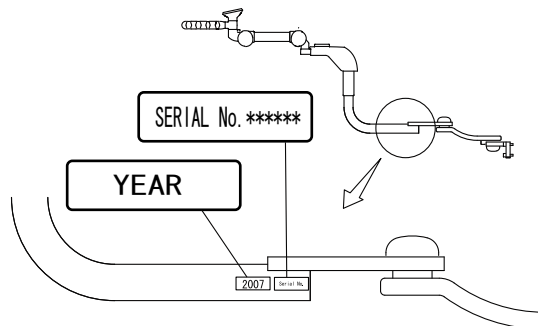

8-3. Product label (SERIAL No.) is located side of the doctor swing arm.

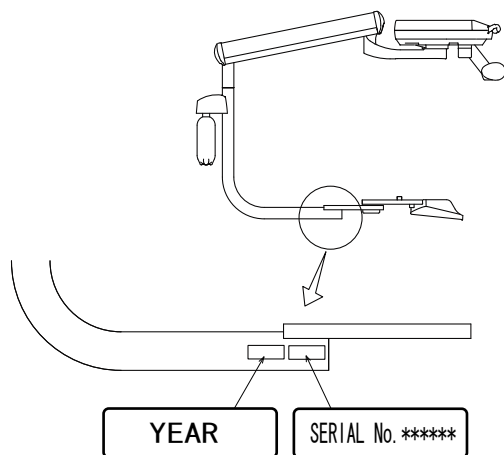

8-4. Product label (SERIAL No.) is located side of the PMU swing arm.

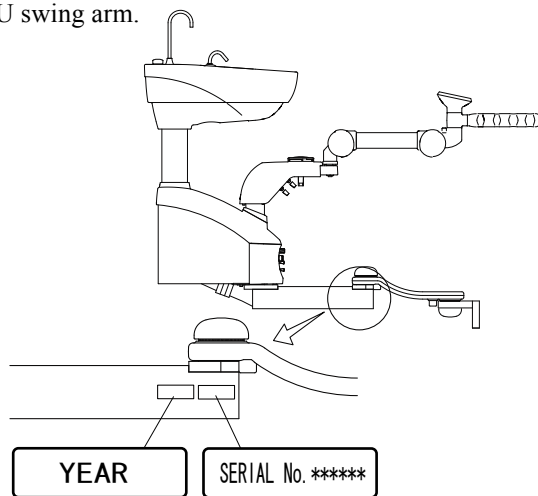

9. LIST OF COMPATIBLE HANDPIECES

Type	Description
Syringe	DCI (3-way)
Air Turbine	NSK Ti-Max X
	NSK Mach-Lite XT
	NSK Pana-Max
	Bien Air Bora S36L / Unifix w/light
Air Motor	Bien Air Aquilon 830 / Unifix w/light / PM1132
	NSK EX-203 / EX-6
Micromotor	Bien Air MX / DMX
	Belmont T-Force DA-700E
Scaler	Belmont Varios Lux DA-150SL

9. Lifetime and disposal

9-1. Lifetime

Provided that the recommended and authorized care and maintenance are correctly performed, the working life-time of this equipment is 10 years from the date of initial shipment from the manufacturer.

9-2. Disposal

This is not an infectious device, but prior to disposal make sure that no parts of the device is infected. Follow the federal, state and local regulations for disposal.

NOTE

Empty rounded rectangular box for notes.



BELMONT EQUIPMENT, Division of Takara Belmont USA, Inc.

101 Belmont Drive Somerset, New Jersey 08873 U.S.A. TEL.:(732) 469-5000 / (800) 223-1192 Fax.:(732)526-6322 / (800) 280-7504

TAKARA CO, CANADA LTD.

2076 S. Sheridan Way, Mississauga, Ont., L5J2M4, Can. TEL.:(905) 822-2755 Fax.:(905)822-6203

TAKARA BELMONT CORPORATION (Manufacturer)

1-1, 2-Chome, Higashi-shinsaibashi, Chu-ku, Osaka 542-0083, Japan TEL.: 81-6-6213-5945 Fax.:81-6-6212-3680